

INTERNATIONAL MONETARY FUND

Structural Transitions to Electric Vehicle Production

Czech Republic

Stephen Ayerst and Neree Noumon

SIP/2023/013

IMF Selected Issues Papers are prepared by IMF staff as background documentation for periodic consultations with member countries. It is based on the information available at the time it was completed on December 12, 2022. This paper is also published separately as IMF Country Report No 23/32.

2023
JAN



SELECTED ISSUES PAPER

IMF Selected Issues Paper
European Department

Structural Transitions to Electric Vehicle Production: Czech Republic
Prepared by Stephen Ayerst and Neree Noumon*

Authorized for distribution by Miguel Segoviano
January 2023

IMF Selected Issues Papers are prepared by IMF staff as background documentation for periodic consultations with member countries. It is based on the information available at the time it was completed on December 12, 2022. This paper is also published separately as IMF Country Report No 23/32.

ABSTRACT: Sustaining the impressive convergence gains allowed by the Czech automotive sector has become challenging due to its comparatively lower value added, lower investments in research and development, and lower skills in the labor market. Using a structural model of global value chains, the paper examines policies to smooth the transition to the production of electric vehicles in Czechia. The analysis explores the impacts of increasing labor productivity, boosting production capabilities, and moving up the global value chain. These policies were found to have a relatively lower impact when they shift specialization towards lower value-added stages of production.

RECOMMENDED CITATION: Ayerst S. and Noumon N. (2023)

JEL Classification Numbers:	E22, F23, J24, L62, L16, C54
Keywords:	Automotive industry, Czech Republic, Convergence, Electric vehicles, Global value chains, Labor productivity, Structural Policy
Author's E-Mail Address:	SAyerst@imf.org ; NNoumon@imf.org

SELECTED ISSUES PAPERS

Structural Transitions to Electric Vehicle Production

Czech Republic



CZECH REPUBLIC

SELECTED ISSUES

December 12, 2022

Approved By
The European Department

Prepared by Stephen Ayerst and Neree Noumon.
Assistance was provided by Ritzy Dumo and
Iyad Alasal (all EUR).

CONTENTS

CZECHIA: STRUCTURAL TRANSITIONS TO ELECTRIC VEHICLE PRODUCTION	2
A. Background: Automotive Production in Czechia	2
B. A Structural Model of the Automotive Global Value Chain	5
C. The Transition to Electric Vehicle Production	8
D. Conclusion and Policy Recommendations	11
FIGURES	
1. Cross-Country Comparison of Productivity and R&D	3
2. Sectoral Share of Czechia Economy	3
3. Intermediate Suppliers and Consumers from Czechia Auto Sector	4
4. Value Added and Skill Intensity of the Automotive Sector	4
5. Electric Vehicle Production in Czechia	4
6. Automotive Global Value Chain Structural Model Illustration	5
7. Illustration of the Automotive GVC	7
8. Transition to Electric Vehicle Production	8
9. Impact of Policy on Employment and Value Added	11
TABLE	
1. Calibrated Parameters	7
ANNEX	
I. Model Description and Calibration	14
References	13

CZECHIA: STRUCTURAL TRANSITIONS TO ELECTRIC VEHICLE PRODUCTION¹

Czechia automotive sector's high integration into global value chains and its large economic contribution have allowed Czechia to experience a period of persistent convergence with advanced European economies. At the same time, sustaining those impressive gains is somewhat constrained by Czechia automotive sector's comparatively lower value added, lower investments in research and development, and lower skills in the labor market. These challenges are exacerbated by in the context of the European automotive market's transition to electric vehicles (EV) for which production tends to be more skill-intensive and concentrated at higher value-added stages of production. This paper examines—through the lenses of a structural model of global value chains— policies that could smooth the transition to the production of electric vehicles in Czechia economy context. In particular, the paper analyzes the impacts of a broad set of policies related to increasing labor productivity, boosting production capabilities in the current set of specialties, and moving up the global value chain.

A. Background: Automotive Production in Czechia

1. **Sustaining Czechia's convergence toward more advanced economies—which has been driven mostly by the auto industry—would require moving up global value chains.** Czechia currently still lies below many advanced economies though above most emerging economies in terms of GDP-per-capita (left panel, Figure 1).² Czechia's rapid convergence was facilitated by a successful leveraging of its automotive sector and geographic proximity with Germany, a key player in the global automotive market. The economy has now entered a challenging stage of its development, which requires transitioning to higher value-added segments of global value chains to sustain the convergence process and further tap into its growth potential. Czechia's lack of progress on this front are reflected in relatively lower R&D spending per inhabitant compared with other advanced European economies (right panel, Figure 1).
2. **The automotive sector is one of the largest sectors in Czechia in terms of output and employment.** Czechia motor vehicle sector's value added and employment shares, stood respectively at 4.9 and 3.2 percent as of 2014 (Figure 2). Furthermore, sectors adjacent to motor vehicles, such as trade of motor vehicles and repair of equipment, are also important sectors in Czechia economy, reflecting the positive spillovers of the auto industry to Czechia industry.³

¹ The analysis benefitted from discussions with the authorities, and the comments received on the presentation that took place during the 2023 Article IV consultation mission.

² GDP per capita is reported in 2019 to avoid the inclusion the impact of the pandemic and subsequent recovery.

³ See, for example, IMF 2022 for an overview of the input-output structure of Czechia economy.

Figure 1. Cross-Country Comparison of Productivity and R&D

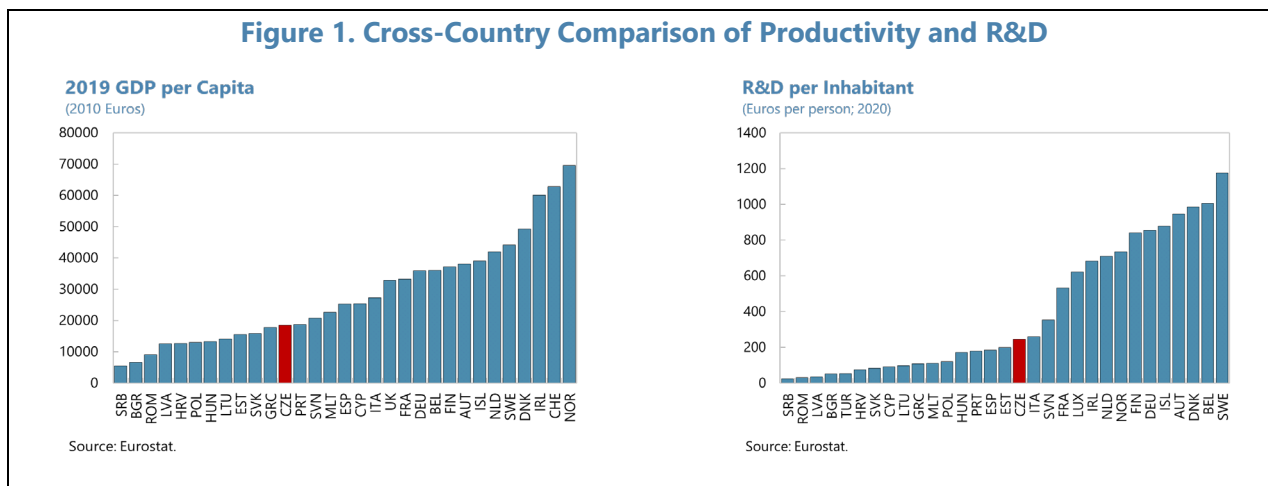

3. Czechia automotive sector is highly integrated into global value chains. Czechia auto industry exhibits large cross-country variations in terms of the sales of suppliers and consumers of intermediate inputs, with some notable large players (Figure 3). Germany stands out as the most important supplier and consumer of Czechia auto sector’s intermediate inputs, reflecting the ownership link between Volkswagen and Skoda Auto. On the intermediate input’s supplier side, Poland, Slovakia, and Italy are the three largest suppliers after Czechia and Germany. On the intermediate input’s consumer side, Russia, France, and Slovakia are the most important individual countries. These upstream and downstream auto value chain linkages tend to be quite strong, indicating the relatively central position of Czechia to the regional value chains.

Figure 2. Sectoral Share of Czechia Economy

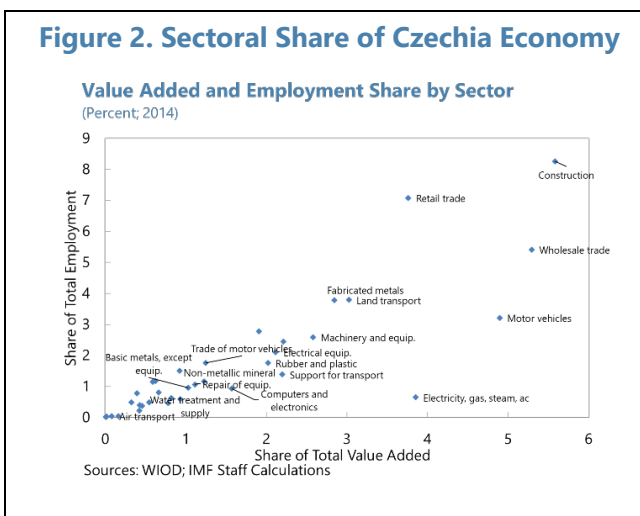

4. Czechia automotive sector’s value-added share and skill intensity are comparatively lower in the regional context. Czechia automotive sector has one of the lowest value-added shares compared to other countries in the region (left panel of Figure 4).⁴ This low value-added share reflects the location of Czechia on the global value chain, in which, Czechia automotive sector tends to produce lower value-added components of vehicles (e.g., Pavlínek, 2022).⁵ In parallel, Czechia also has one of the lowest shares of high-skilled workers in the automotive sector as well as a comparatively lower high-skill population share (Figure 4). By comparison, Germany has one of the highest value-added shares in the auto sector. While the German automotive sector’s high-skill share is only marginally larger than that of

⁴ For comparability, the 2009 data on skill intensity measure is used. Alternative data sources in more recent years (e.g., the OECD TiVa Database) shows broadly similar patterns.

⁵ See also WTO (2019) and World Bank (2020).

Czechia, it benefits from a larger share of high-skilled workers to pull from in the general population.

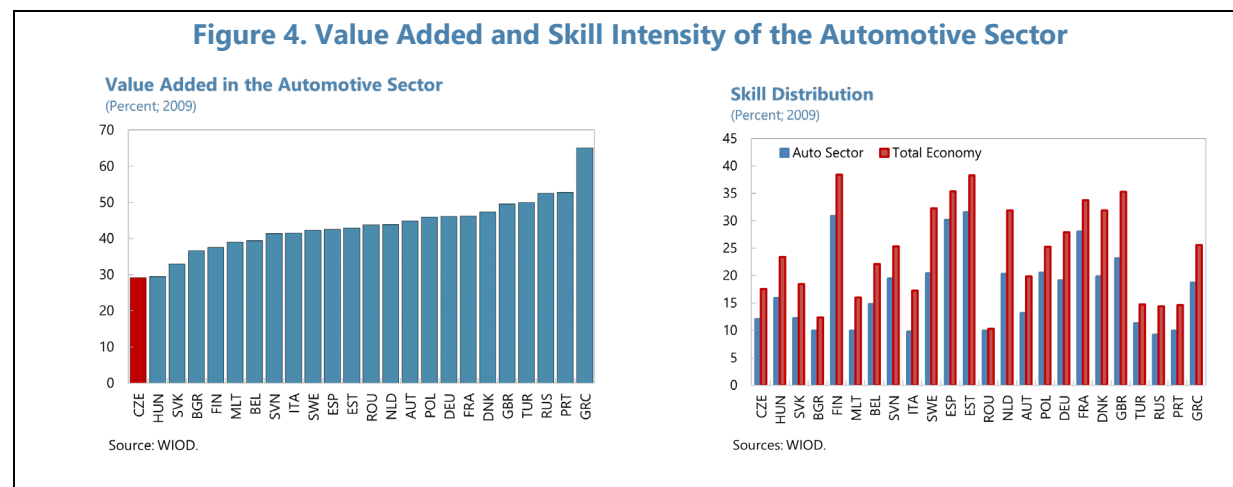
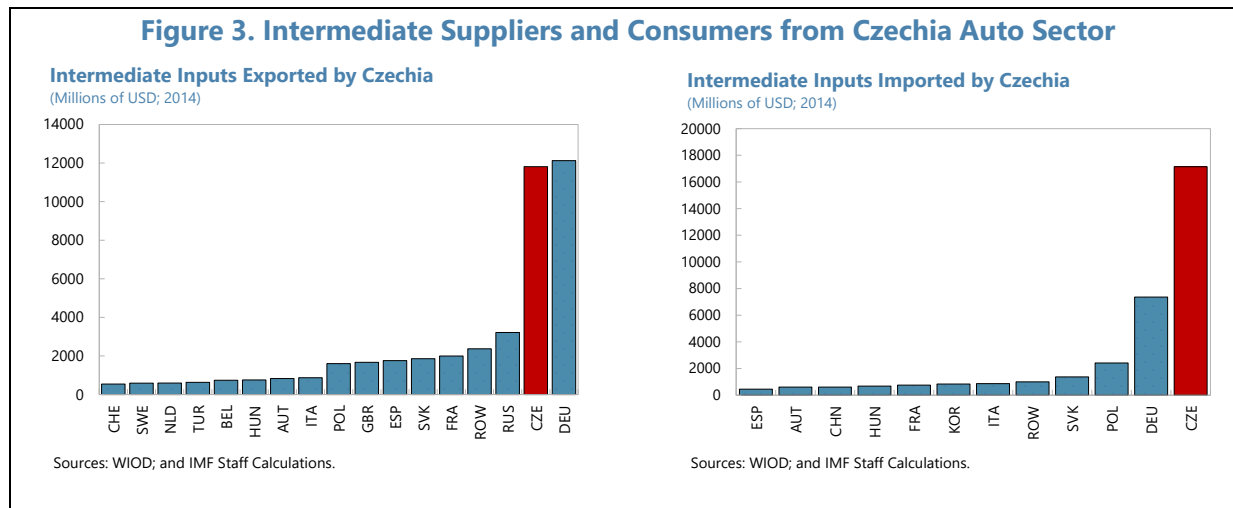

5. Czechia face key challenges and risks in the transition to electric vehicle production. The previous facts have established that Czechia auto sector is an important supplier to the German auto sector, is concentrated in a relatively low value-added section of the value chain and is relative less skill-intensive than other countries in the region. While future developments in the production of electric vehicles remain uncertain, three trends have been observed so far. First, electric vehicle production involves shorter value chains than combustion vehicle production. While Czechia automotive sector currently plays a well-defined

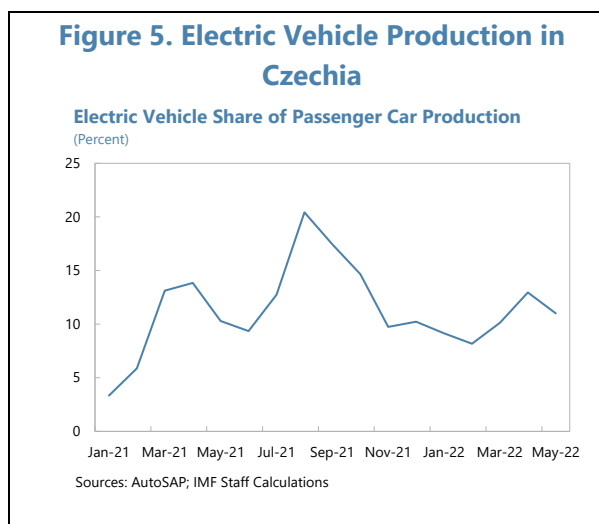

role, it is unclear whether shifts in the geography of value chains will leave this role unchanged.⁶ Second, electric vehicle production tends to be higher value added and involves less labor. The risk to Czechia automotive sector is then that the shift to electric vehicle production will lead to lower labor demand, negatively affecting Czechia economy. Third, electric vehicle production is more skill-intensive than combustion vehicle production. The risk is then that the relatively lower-skilled population will face a more challenging transition period than in other countries in the absence of appropriate policies.

6. Staff analysis investigates the potential impact of a transition to electric vehicles in Europe, through a combination of data and modeling techniques. Section B introduces a stylized structural model of automotive global value chains that includes distinct production of electric and combustion vehicles. The model describes the inter-connectedness of trade and imbeds domestic capability features, including specialization along the global value chain. The model is also calibrated to capture key features of Czechia and Germany's positions in global value chains, as well as key differences between electric and combustion vehicle production. Section C uses the model to examine a hypothetical structural transition to electric vehicle production driven by a shift in consumer demand for electric vehicles. The section then discusses the potential implications of different broad-level policies to offset the negative effects of the transition. Finally, Section D concludes with a discussion of the main findings, policy recommendations, and limitations of the analysis.

B. A Structural Model of the Automotive Global Value Chain

Key Features of the Structural Model

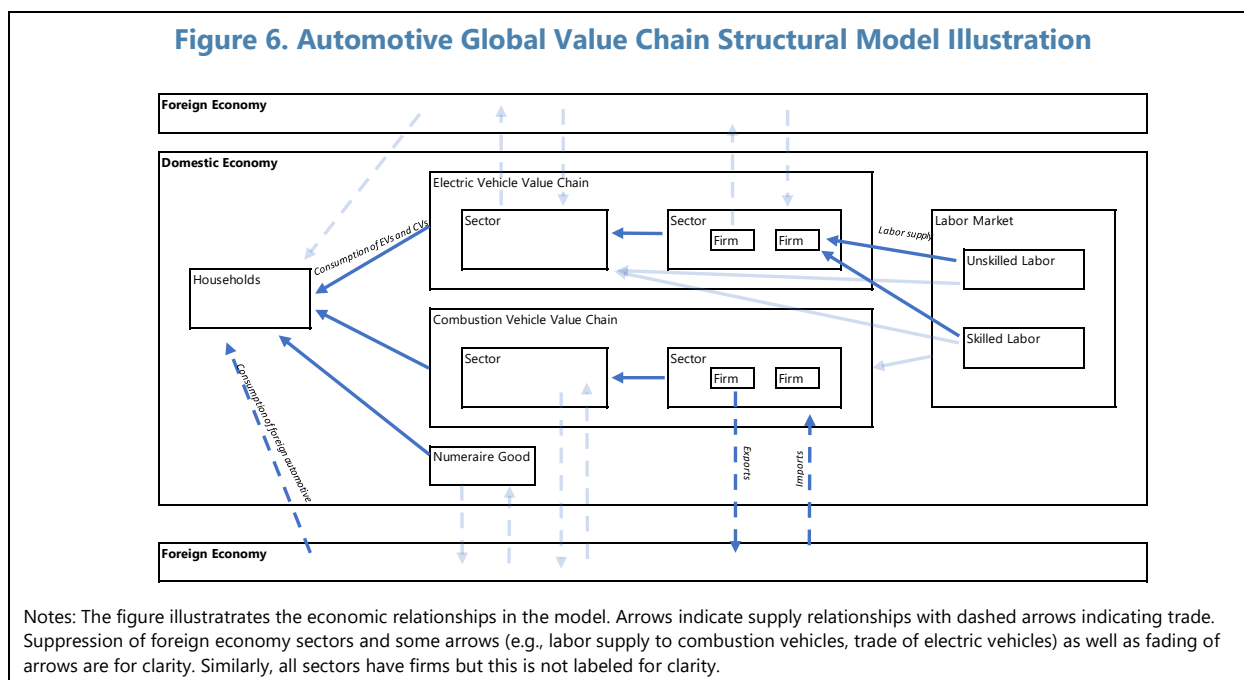

⁶ The energy crisis in Europe could lead to a dislocation of European value chains over the medium-term.

7. The impacts of various policies are analyzed in the framework a structural model of the automotive global value chain. The model developed (Annex I) has three main overlapping structural components (Figure 6) and provides an overview of the value chains involved in the production of electric and combustion vehicles (Figure 7). The economy consists of I countries, each endowed with production technologies $(A_{i,t}^U, A_{i,t}^S)$ that determine the relative cost of unskilled and skilled labor, trade costs with other countries $(\tau_{i,t}^h, f_{i,t}^h)$, and the relative cost of creating new goods $(\psi_{i,t}^h)$. Both electric and combustion vehicles (EV and CV) are produced and the relative demand for each type of vehicle is determined by a taste parameter γ_t which also controls for total EV expenditure. Shifting tastes through higher γ_t drives the structural transition to electric vehicle production in the results. The allocation of economic activity in the equilibrium depends on countries' sectoral capabilities and trade patterns, which are inter-connected factors (Annex I).

- a. **Value chains.** The production side of the economy is composed of two value chains—corresponding to electric and combustion vehicles—and a numeraire good. The value chains consist of different stages of production, referred to as sectors and denoted by h . Each sector is composed of heterogeneous goods that differ in terms of their relative productivity and use both skilled and unskilled labor as inputs. The relative labor intensity of a sector is denoted by α^h and the relative skill intensity by β^h .
- b. **Trade of goods.** Sector h goods produced in the domestic economy i can be traded to any foreign economy j by paying a variable trade cost $\tau_{i,j}^h$ and fixed trade cost $f_{i,j}^h$. The fixed trade cost implies that in equilibrium only the most productive goods are sold in foreign market.
- c. **Entry of new goods.** The final component of the economy determines the mass of goods produced in equilibrium. Firms in each sector pay a convex cost that allows them to produce new varieties of goods that differ in terms of productivity. Productivity is used in the creation of new goods and determines its relative profitability for the firm. The mass of goods determines the overall economic activity in a sector—for a given level of trade costs and cost of labor—and can be equivalently thought of as total factor productivity. Given this interpretation, the mass of goods is used interchangeable with a country's sectoral capabilities.
- d. **Capital.** Capital, which is not explicitly modeled, has two important properties for the production process, as: (i) an alternative input to labor; and (ii) an input that can be accumulated which has important implications for sectoral dynamics and build-up of sectoral capabilities. Regarding the first property, intermediate inputs play a similar role in the model's production process, so including capital as a third factor of production would matter to the extent that it affects the labor share of production α^h . On the second property, capital accumulation could be proxied by the entry of new goods which plays a similar role as capital given it requires country-sector-specific investments to increase production. Since capital investment would be subject to similar incentives and costs as the entry of new goods, capital would tend to amplify country-level differences in sectoral capabilities and related dynamics during the transition.

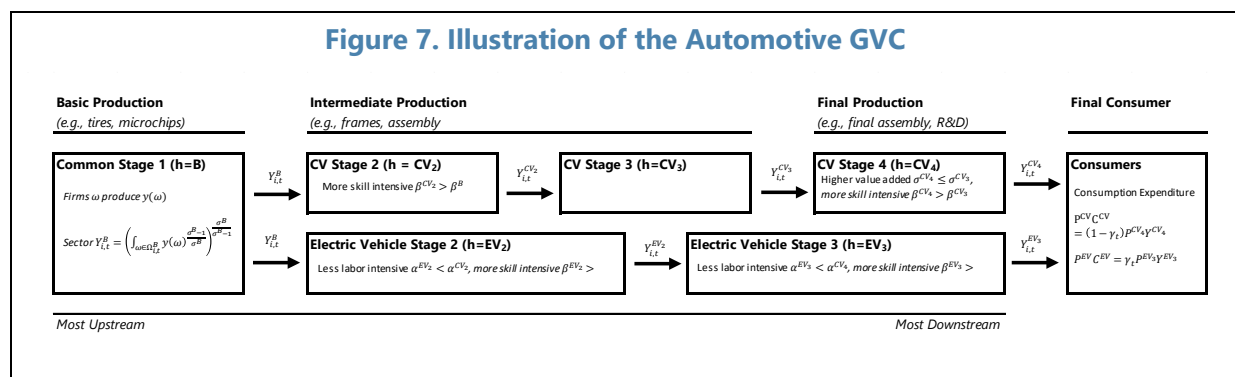

Model Calibrations

8. The model is calibrated to the features of combustion vehicle production based on data and also reflects key differences with electric vehicle production. The calibration is based on recent data for automotive production to discipline the parameters for combustion vehicle production (Table 1). The parameterization of electric vehicle production is set to match differences (Section A) between combustion and electric vehicle production. The sectors for each production stage are constructed using the input-output tables associated with the automotive sector (Annex I.2). The calibration is for illustrative purposes and is not intended to represent a quantitative assessment of the transition. The transition to EV is mimicked by changing the taste parameter γ for electric vehicle consumption. The global economy is modeled as being composed of three countries ($i \in \mathcal{J} = \{\text{CZE, DEU, ROW}\}$): Czechia (CZE), Germany (DEU), and the rest of the world (ROW). Trade costs are estimated to match within-sector trade flows across countries and scaled to match the relative use of intermediate inputs for Czechia in Figure 3, around 50 percent (Annex I.3).

Table 1. Czechia: Calibrated Parameters

Common Parameters		
Discount Rate (%)	ρ	4
EV Preference (%)	γ	10
Productivity Distribution	θ	5.0
Exit Probability	δ	0.1
Country-Specific Parameters		
Productivity of Unskilled Workers	$A_{i,t}^U$	[1.00, 0.91, 1.25]
Productivity of Skilled Workers	$A_{i,t}^S$	[0.67, 0.76, 0.63]
Sector Specific Parameters		
Elasticity of Substitution	σ^h	[3.0, 3.0, 3.0, 2.5, 3.0, 2.5]
Labor Share	α^h	[0.7, 0.5, 0.5, 0.5, 0.8, 0.6]
Skill Intensity	β^h	[0.2, 0.2, 0.2, 0.4, 0.3, 0.5]
Other Parameters (reported as country average)		
Entry Cost	ψ_i^h	[1.07, 1.02, 1.03]
Variable Trade Cost	$\tau_{i,j}^h$	[1.07, 1.06, 1.06]
Fixed Trade Cost	$f_{i,j}^h$	[0.107, 0.106, 0.106]

Notes: Sector-specific parameters are presented such that the first element is used in the production of both electric and combustion vehicles, the second through fourth element characterize combustion vehicle production, and the fifth and sixth element characterize the electric vehicle production. The value chain variables are ordered from most upstream to most downstream. Country-specifics parameters are ordered as Czechia, Germany, Rest of World.

C. The Transition to Electric Vehicle Production

The Impact of Transitioning to EV Production by 2035

9. The model illustrates the steady state impacts of transitioning to electric vehicle production in Europe. The calibrated equilibrium in line with current policies, (baseline equilibrium) is compared with the equilibrium in which expenditures on electric vehicles increases to 90 percent of automotive expenditures (EV equilibrium). The EV equilibrium could be thought of as capturing the automotive sector around 20 years in the future after the EU’s “Fit for 55” goal—to ban the combusive engine by 2035—has become effective. The results (Figure 8) are presented as a comparison of steady states and could be interpreted as the 2035 economy relative to the current state of the economy.⁷ In this regard, the quantitative magnitude of the results should be viewed as illustrative.⁸ Accordingly, the results are scaled such that the absolute value of the change in Czechia is normalized to one.

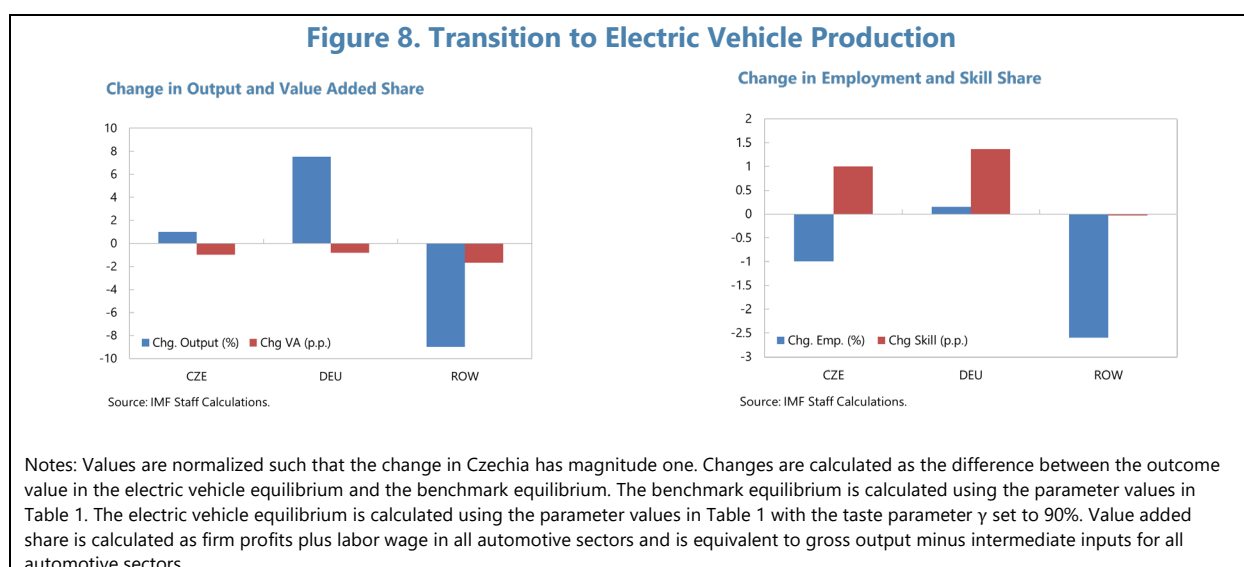

10. The transition to electric vehicle production is projected to negatively affect Czechia automotive sector. Figure 8 summarizes the EV transition impact on employment and value added relative to the baseline calibration for Czechia, Germany, and the rest of the world.⁹ For Czechia, the transition leads to an increase—though comparatively marginal—in the automotive sector’s output and the share of high-skilled workers (skill share). The increase in output is driven by the narrowing of the value chain allowing Czechia to push out countries in the rest of world that have a competitive disadvantage in higher value-added sectors. Conversely, the EV transition is expected to

⁷ The same broad results will apply over the transition path, albeit quantitatively smaller since electric production will account for a smaller share of the overall sector.

⁸ The results should be taken as removing trends in productivity and population from countries and sectors. That is, the results assume that overall labor productivity is held at its current value.

⁹ The model is also used to simulate a partial transition to electric vehicle production in which only half of final expenditure is on electric vehicles. While this is not strictly required by the model, the overall change from the baseline economy is around half of what is presented in Figure 8.

reduce the value-added share and overall employment relative to the baseline. The decrease in the value-added share and the increase in the skill intensity follow directly from the assumptions on the relative parameterizations of electric vehicle production (Figure 7 or Table 1) while the decline in employment is closely linked to the decline in value added and the change in the labor intensity of production. Overall, the model accommodates several channels through which policy can operate to support the automotive sector over the transition, which are explored next.

Policies to Maximize the Benefits of the Transition to EV Production

11. The model is used to simulate three broad policy schemes that could potentially aid the structural transition to electric vehicle production. As discussed below, these broad policy schemes are taken as stand-ins for groups of more specialized policies that could be implemented by the government.

- a. ***Boosting labor productivity.*** The first group of policies is related to investments to increase or enhance the share of skilled labor, which is comparatively low in Czechia automotive sector, and more broadly at the aggregate level (Figure 4). This policy is implemented in the model by increasing Czechia labor productivity to match that of Germany, making skilled labor more abundant and cheaper. In practice, this group of policies captures any labor productivity enhancing policies, including investing in education, upskilling, re-skilling, and lifelong learning programs, as well as digitalization policies that could boost existing skills.
- b. ***Support for horizontal production capabilities.*** The second set of policies considered relates to investments in the capabilities of the automotive sector where Czechia economy already performs well. This policy is implemented in the model by reducing the entry cost of Czechia for intermediate sectors in both the electric and combustion vehicle (CV stage 3 and EV stage 2) production by 20 percent. This policy scheme could alternatively be thought of as a reinforcement of the country's current production capabilities and specializations. In practice, this policy includes improving the (global) competitiveness of the automotive sector as it is currently structured, including investing in infrastructure, subsidies to operations of current firms, or lowering trade costs.
- c. ***Support for vertical production capabilities.*** While the second policy reinforces existing capabilities, the third policy scheme promotes moving up the global value chain through investments in capabilities that are not yet the comparative advantage of Czechia economy. This policy is implemented in the model by reducing the entry cost of the most downstream sectors for both electric and combustion vehicle production by around 20 percent, which facilitate the shift to higher value added and more skill-intensive sectors. In practice, this policy should be thought of as capturing any policy enhancing downstream activities, including research and development subsidies, lowering cost of new firm or product entry, or labor market policies that allow access to foreign experts.

Policy Impact of Various Policy Options to Ease the Transition to EV Production

12. Boosting labor productivity or supporting higher-value segments would yield a comparatively higher returns than horizontal policies. The outcome of the policy experiments mentioned above vary in terms of their impacts on output, the value-added share, employment, and the skill share (Figure 8). For comparability, the impacts are expressed as the change in the equilibrium outcomes under the policy scheme relative to the electric vehicle equilibrium (defined above).

13. Boosting labor productivity leads to an increase in output, employment, the skill intensity of the economy, and the value-added share. Higher labor productivity allows Czechia to move towards higher value-added sectors, and thus rebalances the productions of the intermediate EV sector and the final EV sector relative to the baseline. In particular, some of Czechia's intermediate EV sector production would be produced in Germany, while part of the Germany's final EV sector production would be produced in Czechia.

14. Policies to support horizontal production capabilities could paradoxically have negative effects on Czechia automotive sector across four dimensions. This effect could be attributed to the allocation of economic activity across sectors implied by horizontal policies. In Czechia, these policies are associated with a higher investment in the production of intermediate goods (e.g., EV car frames). While horizontal policies have a positive direct impact on the automotive sector in terms of increased production of intermediate goods (e.g., car frames), they also indirectly affect the final production goods (e.g., final assembly) through two channels in the model (section B).

- a. **Domestic competitiveness effect.** In the short-term the final good becomes cheaper to produce, and more profitable, in both Czechia and abroad because due to cheaper Czechia intermediate inputs, which also has a positive impact on Czechia automotive sector.
- b. **Global competition effects.** Second, all else equal, increased profitability of the final good production incentivizes investments that increase final good capabilities in both the domestic market and abroad. This results in increased global competition for Czechia final good producers, which over time negatively impact Czechia automotive sector, dominating other effects and leading to an overall negative impact on Czechia automotive sector. The negative impact dominates partly due to fact that horizontal policies lead to reallocation of activity from a relatively favorable stage of production (final good) to a relatively unfavorable stage of production (intermediate production).

15. Policies enhancing vertical production capabilities yield higher value-added, employment and share of skilled labor. Investing in vertical (downstream) production capabilities would increase Czechia's capabilities in relatively high value-added final stage of production, causing both value added and employment to increase. Indeed, the resulting lower cost of entry in the final EV sector from these policies allows for more goods to be produced in Czechia. This leads to an increase in the economic activity since the final EV sector tends to be higher value added as well as more labor and skill intensive. It is also worth noting that both vertical policies and policies to improve labor productivity have relatively similar effects on the economy. In this regard, the model highlights an important economic

intuition for policy design. Policies can achieve similar goals through either directing economic activity towards specific sectors or by making the conditions around those sectors more favorable.

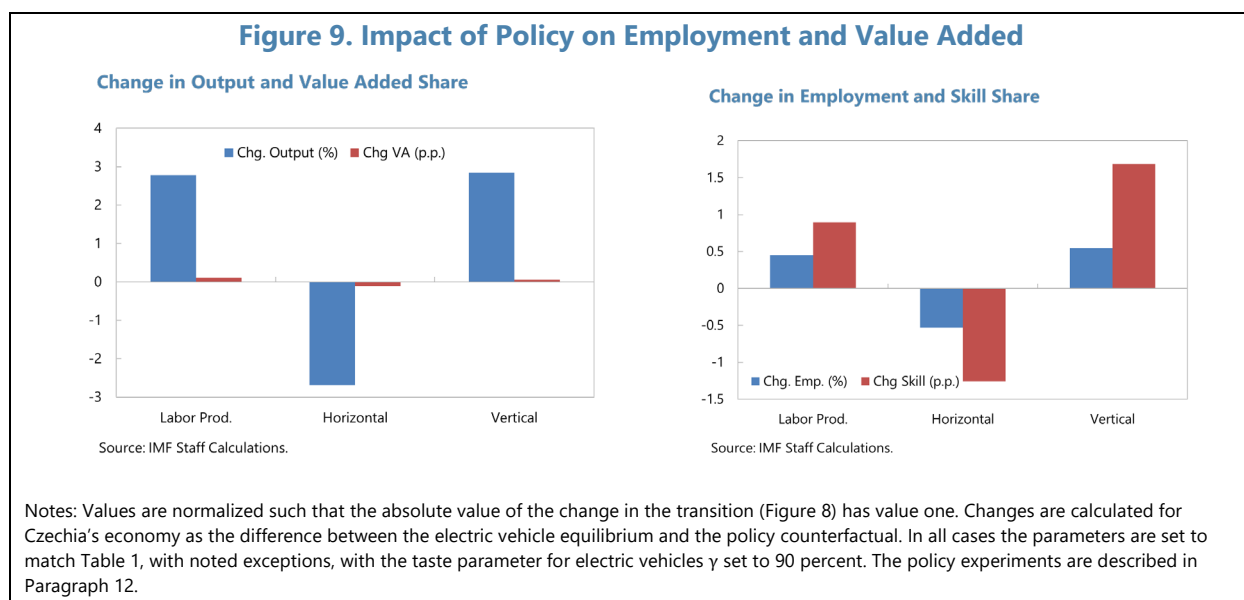

D. Conclusion and Policy Recommendations

16. Clear and directed policy can help minimize potential headwinds in the transition to electric vehicle production. The concentration of Czechia economy in the automotive sector has allowed the economy to experience persistent convergence with advanced European economies. This concentration could hinder growth if the economy is unable to adapt to changing trends in automotive production. This analysis highlighted key dimensions of Czechia economy's current position that may become weaknesses in the transition to electric vehicle production. Policy to address these challenges should be carefully designed to incentivize appropriate investments throughout the value chain. Scaling up investments in the skills required to boost labor productivity would help prepare the economy for new EV-related production processes. Furthermore, investing in both horizontal and vertical capabilities would allow the economy to take a more active role in the EV production chain. However, these policies have a relatively lower impact if they cause the specialization of the economy to shift towards lower value-added and lower employment stages of production. Finally, these policies require large investments thus should well planned, sequenced and targeted to maximize government capacity and labor resources.

17. Further policy considerations would be needed to account for factors outside the scope of this paper. First, the model assumes that final demand will shift uniformly across countries to reflect the transition to electric vehicles and the EU's "Fit for 55" goal that all vehicles sold should be zero emissions by 2035. However, many countries—Czechia included—may choose not to fully phase out combustion vehicle, which would lead to a comparative advantage for Czechia auto sector if it chose to remain invested in these sectors. This could potentially soften the impact of the transition but may prove to be an additional hurdle if it further disincentivizes firms from investing in electric vehicle production. Second, the model does not directly consider the role of infrastructure or other forms of capital

investment, which are important for both the adoption of electric vehicles by end-consumers (e.g., charging stations) and electric vehicle production (e.g., factories). In this regard, an additional policy angle may be to subsidize the development of new electric vehicle production facilities. From the model perspective, this would be qualitatively similar to the considered policies that lower the cost of entry for new goods and the broad lessons should apply, since both examine the dynamic build-up of resources (i.e., capital and goods).

References

- Chaney, Thomas. 2008, "Distorted Gravity: The Intensive and Extensive Margins of International Trade." *American Economic Review* 1707–21.
- IMF 2022, *2021 Article IV Consultation*, IMF.
- Melitz, Marc, 2003, "The Impact of Trade on Intra-Industry Reallocations and Aggregate Industry Productivity." *Econometrica* 1695--1725.
- Pavlínek, P., (2022), Transition of the Automotive Industry towards Electric Vehicle Production in the East European Integrated Periphery, *Empirica*, 1–39.
- The World Bank. 2020, *Trading For Development: In the Age of Global Value Chains*, The World Bank Group.
- World Trade Organization. 2019, *Czechia: Trade in Value Added and Global Value Chains*. World Trade Organization.

Annex I. Model Description and Calibration

This annex discusses in more details the model including the construction of the value chains, as well as the model parameters and their calibrations.

Description of Model

1. Countries and Household Preferences. The economy is populated by I countries, which we index by i and j . Each country i is populated by a mass U_i of unskilled workers and a mass S_i of skilled workers that we assume are strictly greater than the labor employed in the automotive sector. Households have preferences over the consumption of a numeraire good C^0 and an automotive good C given by

$$U_i = \int_{t=0}^{\infty} e^{-\rho t} [C_{i,t}^0 + \log C_{i,t}] dt.$$

2. Production of the Numeraire Good. The numeraire good is freely traded and produced in each country by a representative firm that employs both unskilled and skilled labor. The production technology is given by

$$Y_t^0 = \frac{U_{i,t}}{A_{i,t}^U} + \frac{S_{i,t}}{A_{i,t}^S},$$

where $A_{i,t}^U$ and $A_{i,t}^S$ are parameters that describe the relative productivity of unskilled and skilled labor in the economy. Given that the goods are perfect substitutes in the production of the numeraire and both types of labor are employed in equilibrium, by assumption, the wage rate of each type of labor is dictated by its productivity and the price of the numeraire good, which is normalized to unity.

3. Final Automotive Good. The automotive good is comprised of both combustion vehicles (CV) and electric vehicles (EV). Demand for the two types of vehicles is given by a Cobb-Douglas preference as

$$Y_t = (Y_t^{CV})^{1-\gamma_t} (Y_t^{EV})^{\gamma_t},$$

where γ_t is a taste parameter that determines how much households prefer electric to combustion vehicles. Our experiment involves decreasing the value of the taste parameter to simulate a transition of consumption from combustion to electric vehicles.

4. Global Value Chains. Production of both combustion and electric vehicles are described by a value chain where we refer to each point on the value chain as sectors. Sectors are indexed by h and k . Production is sequential, such that the output of one sector requires inputs from an input sector. For example, the sale of the final combustion good uses inputs from an intermediate stage (e.g., the assembly of the car). We describe the value chains as vectors \mathcal{H}^{CV} (and \mathcal{H}^{EV}) where the elements correspond to the sectors used in the production of the final combustion (and electric) vehicle and

higher indexed stages correspond to more downstream production. Sectors may be repeated in the production of both combustion and electric vehicles and the numeraire sector is assumed to be the most upstream sector in both value chains. For example, the calibrated production process is described by $\mathcal{H}^{CV} = \{0,1,2,3,4\}$ and $\mathcal{H}^{EV} = \{0,1,5,6\}$ where the final production of combustion and electric vehicles would correspond to sectors 4 and 6.

5. Sectoral Production. Within sectors, intermediate firms produce differentiated varieties ω of goods and then aggregated by a representative final good producer. The final good producers purchase intermediate goods from both domestic or foreign producers, where the final set of goods used is denoted by $\Omega_{i,t}^h$. The representative sectoral firm uses the production technology

$$Y_{i,t}^h = \left(\int_{\Omega_{i,t}^h} (y(\omega))^{\frac{\sigma^h-1}{\sigma^h}} d\omega \right)^{\frac{\sigma^h}{\sigma^h-1}},$$

where σ is a parameter that determines the substitutability between intermediate goods within the sector. Intermediate good producers use labor and the upstream sectors inputs as inputs. Specifically, production of the intermediate variety ω is given by

$$y(\omega) = a_{i,t}^h(\omega) \left(\ell_{i,t}^h(\omega) \right)^{\alpha^h} \left(x_{i,t}^h(\omega) \right)^{1-\alpha^h},$$

Where $a_{i,t}^h(\omega)$ is the productivity of producing variety ω ; $\ell_{i,t}^h(\omega)$ is the composite labor input of variety ω ; and $x_{i,t}^h(\omega)$ is the inputs of output from the upstream sector to sector h . That is, if h is the n th stage of the value chain, $x_{i,t}^h(\omega)$ is the quantity of output used from the sector at the $n - 1$ th stage of the value chain. The labor composite is given by

$$\ell_{i,t}^h(\omega) = \left(u_{i,t}^h(\omega) \right)^{1-\beta^h} \left(s_{i,t}^h(\omega) \right)^{\beta^h},$$

Where β^h is a parameter describing the relative skill intensity of sector h .

6. Trade Costs. Trade follows Melitz (2003). A firm that produces variety ω in country i chooses to enter each market j by paying a fixed cost $f_{i,j}^h$ and paying an iceberg trade cost $\tau_{i,j}^h$ on all goods sold to this market.

7. Entry and Exit. In each country i , a unit mass of monopolists invests in costly entry to create new varieties. A new variety is created at rate z by paying cost $\frac{\psi_i^h}{2} z^2$, where ψ_i^h is a parameter determining the cost of entry. Following Chaney (2008), new varieties draw a productivity a from a Pareto distribution $1 - a^{-\theta}$ after entry. The new variety is then sold off to a firm for its market value. The variety exits if the managing firm chooses not to enter any market or it receives an exogenous shock to exit at rate δ .

Construction of Global Value Chain Data

8. Data. Data comes from the World Input-Output Database for 2014. The data includes the sale of goods and services from sector h to sector k , which is denoted as $sales(h, k)$. Additionally, the Socio-Economic Accounts for 2011 are used to construct information on the relative skill intensity and share of value added for each sector. The more disaggregated data in the new data is aggregated into the previous sectoral allocations to construct the weights discussed below.

9. Mapping the Model into Data. Given that electric vehicle production accounts for a relatively small portion of automotive production, the data is used to discipline the value chain for combustion vehicles in the model. The focal sector is taken to be the *Manufacture of Motor Vehicles, Trailers, and Semi-Trailers* (sector $h = MV$) in the dataset. This is assigned as the third node on the value chain with four nodes, i.e., in model terms $\mathcal{H}^{CV} = \{0, 1, 2, MV, 4\}$. The challenge of the upstream and downstream sectors from this node is that, in the data, sectors do not only capture the activity that is related to the value chain. For example, while the production of *machinery and equipment* is an important input into the automotive sectors, it is also used as an input by other value chains in other sectors. This issue is addressed by constructing representative upstream and downstream sectors in the data as stand-in for the model counterparts. This process is discussed in the remainder of the Annex.

10. Sector Weights and Characteristics. To match the data with the model, upstream and downstream sectors in the data are used to capture the average characteristics of upstream and downstream production. The strength of a supply and demand link between a sector h and k is given by:

$$\phi^S(h, k) = \frac{sales(h, k)}{\sum_{h'} sales(h', k)} \quad \text{and} \quad \phi^D(h, k) = \frac{sales(h, k)}{\sum_{k'} sales(h, k')}.$$

The supply weight captures the importance of sector h to the inputs of sector k relative to all other inputs. The demand weight captures the importance of sector k as a consumer of sector h relative to all other consumers. The Table below describes the relative weight of sectors in the database and provides key sectors in the World Input-Output Database. The weights w_n^h on sector h for stage n of production is used to construct the model sector characteristics for the combustion value chain.

Table 1. Czechia: Mapping Model GVC to Data

Sector	Stage	Weight	Key WIOD Sector
Sales	4	$w_4^h = \phi^D(MV, h)$	Manufacture of motor vehicles, trailers, and semi-trailers; Wholesale and retail trade and repair of motor vehicles and motorcycles; retail trade; wholesale trade; land transport; legal and accounting.
Assembly	3	$w_3^{MV} = 1$	Manufacture of motor vehicles, trailers, and semi-trailers
Intermediate Production	2	$w_2^h = \phi^S(h, MV)$	Manufacture of motor vehicles, trailer, and semi-trailers; Machinery and Equipment; Wholesale Trade; Land Transport.
Basic Production	1	$w_1^h = \sum_{k'} \phi^S(h, k') \times \phi^S(k', MV)$	Rubber and plastics; basic metals, except equipment; Fabricated Metals; Computers and Electronics; Machinery and Equipment

Estimating Trade Costs

11. Sectoral Trade Costs. For each sector in the data, trade costs are estimated using the Head-Reis Index as

$$t_{i,j}^h = \sqrt{\frac{\text{trade}_{i,j}^h}{\text{trade}_{i,i}^h} \times \frac{\text{trade}_{j,i}^h}{\text{trade}_{j,j}^h}}$$

This assumes that trade costs are symmetric between countries. The trade costs for the model sectors h are then constructed using the weights described in I.2. In the model, trade costs are comprised of both a variable $\tau_{i,j}^h$ and a fixed $f_{i,j}^h$ component. It follows that

$$\ln t_{i,j}^h = \theta \ln \frac{\tau_{i,j}^h}{\tau_{i,i}^h} - \left(1 - \frac{\theta}{\sigma - 1}\right) \ln \frac{f_{i,j}^h}{f_{i,i}^h}$$

where $\tau_{i,i}^h$ is normalized to one to reflect that there is no additional loss of selling goods locally. Since the fixed and variable components are not directly observed in the data, the two components are allocated based on an assumption that the two costs are equal up to a constant, such that $\tau_{i,j}^h = \bar{f} \times f_{i,j}^h$.

Model Calibration

12. The model is calibrated to match characteristics of combustion vehicle production in the data and assumed differences in electric vehicle production. The calibration is based on data for current automotive production to discipline the parameters (Table 1) for combustion vehicle production.

- a. **Countries.** The global economy is modeled as having countries $i \in \mathcal{I} = \{1,2,3\}$ that correspond to Czechia (CZE), Germany (DEU), as a stand-in for the rest of the world (ROW). The rest of the world captures the trade flows from Czechia and Germany to all other countries. The share of skilled labor is chosen as the midpoint of the distribution (Figure 4).
- b. **Combustion and Electric Vehicle Production.** Combustion and electric vehicle production requires stark differences. Sectors are chosen to match the production process outlined in Figure 7, with the same relative characteristics. The stand-in sectors for each stage of production are constructed using the input-output tables associated with the automotive sector (Annex I.2). The elasticity of substitution is set to $\sigma^h = 3$ with a slightly higher value chosen in the final stages of production to capture the higher value added. The labor shares of production α^h are set to be higher in more upstream sectors to capture a lower dependence on intermediate inputs. The skill intensity β^h is set to match the value in Figure 4 for most sectors and a higher value is chosen for the final stages of production to capture the larger dependency on skilled labor. Electric vehicle production is assumed to have a lower labor share α^h and a higher skill intensity β^h at each stage of production.
- c. **Trade Costs.** Trade costs are estimated to match within-sector trade flows across countries and scaled to match the relative use of intermediate inputs for Czechia in Figure 3, around 50 percent (Annex I.3).
- d. **Country-Specific Labor Productivity.** Since productivities $A_{i,t}^U$ and $A_{i,t}^S$ determine the relative cost of unskilled and skill labor, they should be viewed as determining the effective wage of labor, i.e., the cost per effective unit of labor. Thus, a country with higher wages may have lower effective wages if productivity is high enough. The productivity of unskilled labor in Czechia is normalized to unity. Germany is assumed to have relatively expensive unskilled labor but relatively cheap skilled labor. The Rest of World economy is assumed to have the cheapest unskilled labor but the most expensive skilled labor.
- e. **Entry Costs.** The final step in the calibration is the country-sector entry costs ψ_i^h , a key determinant of the relative mass of goods produced in equilibrium. Entry costs are normalized such that the entry cost in the common sector is one for Czechia. Entry costs are then set such that Germany has a comparative advantage in more downstream sectors while the Rest of World has a comparative advantage in the most upstream sectors.

Model Equilibrium

13. The model's equilibrium describes countries' choices in different stages of GVC and various trade patterns. The allocation of economic activity in equilibrium depends on countries' sectoral capabilities and their trade patterns, which are inter-connected factors.

- a. **Sector Capabilities.** A country's capabilities in a sector h is determined by investment to produce new varieties of goods. Firms invest more in goods for which the country is relatively well suited, due to a combination of trade costs with other countries $(\tau_{i,j}^h, f_{i,j}^h)$,

productivity ($A_{i,t}^U, A_{i,t}^S$), relative cost of skilled labor, and/or cost of entry ($\psi_{i,t}^h$). The organization of sectors into value chains links the relative suitability of a sector in a country to the access to upstream intermediate inputs and downstream consumers. Consequently, the trade pattern determines the relative suitability of each country, and thus the countries' sector capabilities.

- b. Trade Patterns.** A country's capabilities in each sector determines its relative trade in each sector. Specifically, each good produced in the domestic country is traded in foreign markets if that good is sufficiently productive to offset the variable and fixed trade costs. Countries that produce more varieties of a sector's good will tend to trade more of that sector. Consequently, the sectoral capabilities determine the overall trade pattern of the economy.