

Important Information With Illustration Every Engineer Need To Know

engineeringdiscoveries.com/important-information-with-illustration-every-engineer-need-to-know

April 10, 2022

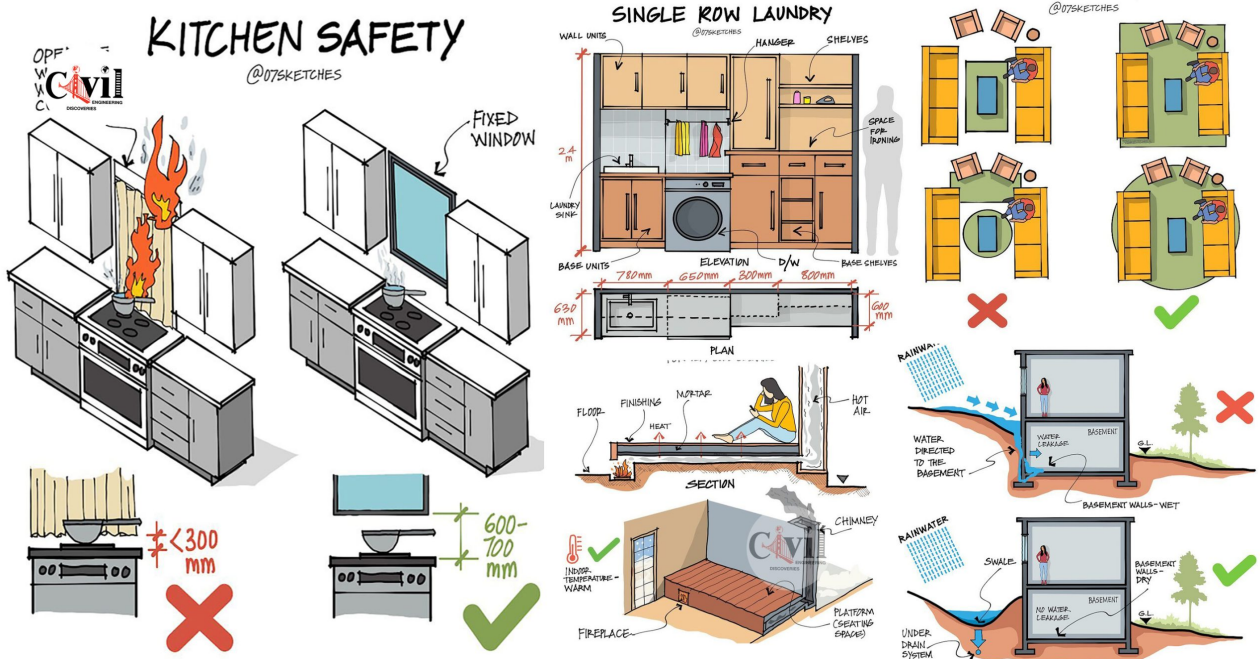

Important information points and dimensions about the kitchen, living room, lighting, closet, laundry, drainage system, types of stairs, etc, by [07sketches](https://www.instagram.com/07sketches).

[Click Here To See Design Tips And Utilities By Arquigraphi](#)

KITCHEN SAFETY

@07SKETCHES

OPERABLE WINDOW WITH CURTAIN



FIXED WINDOW

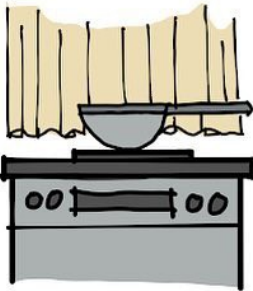
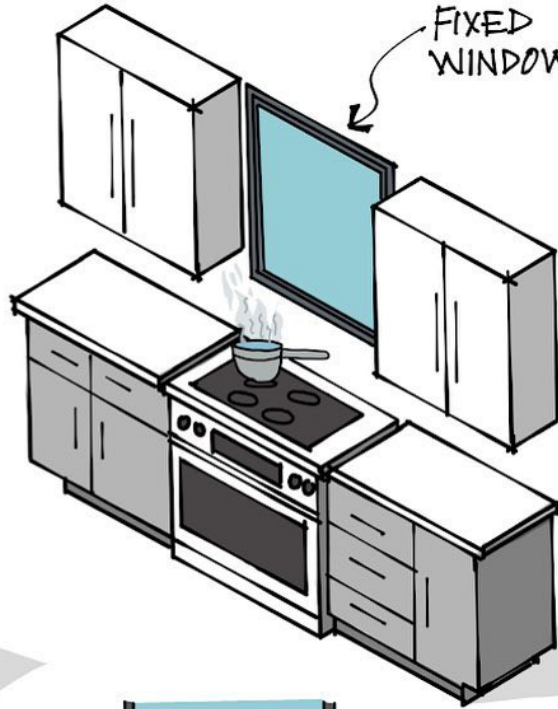

$\neq < 300$
mm



600-
700
mm



KITCHEN DESIGN

@07SKETCHES

- ✗ ① MAIN AISLE WIDTH IS MINIMAL
- ✗ ② KITCHEN TRIANGLE IS LESS THAN 9 FEET, WHICH IS TOO SMALL
- ✗ ③ BASE CABINET IS NOT ACCESSIBLE
- ✗ ④ DISHWASHER AND OVEN DOORS WILL COLIDE
- ✗ ⑤ DEAD SPACE/COUNTER
- ✓ ① EFFICIENT AISLE WIDTH
- ✓ ② BIGGER WORKING TRIANGLE
- ✓ ③ BASE CABINET IS ACCESSIBLE
- ✓ ④ CLEANUP STORAGE AND CONVENIENT DISH STORAGE
- ✓ ⑤ CONTINUOUS AND ACCESSIBLE CABINET+COUNTERTOP

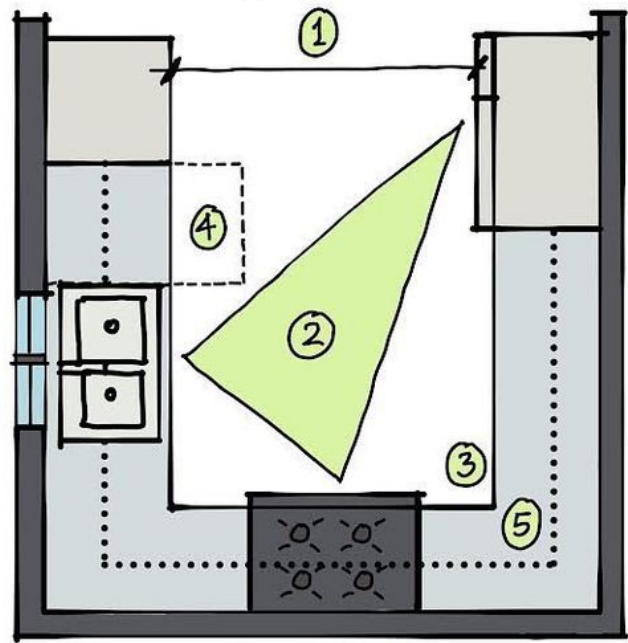
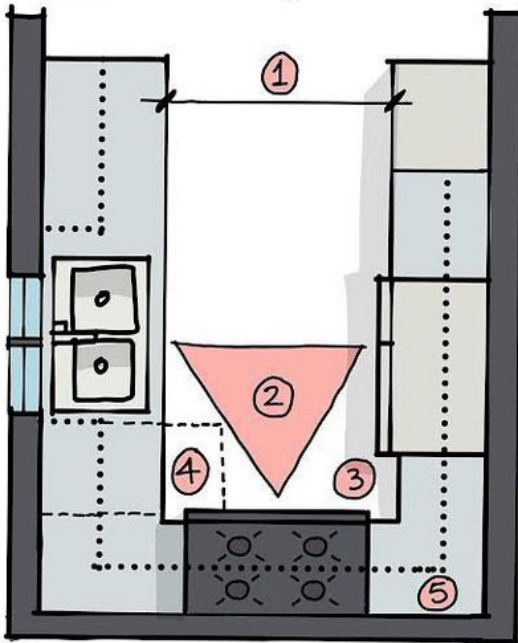

LIVING ROOM - RUG PLACEMENT

@07SKETCHES

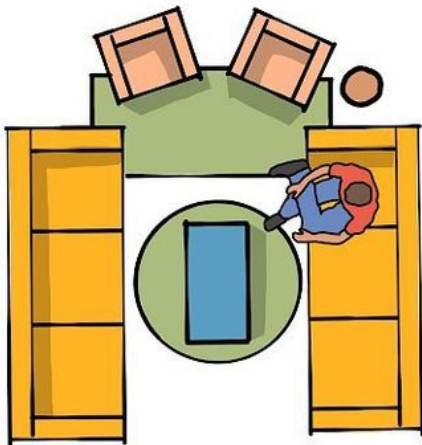
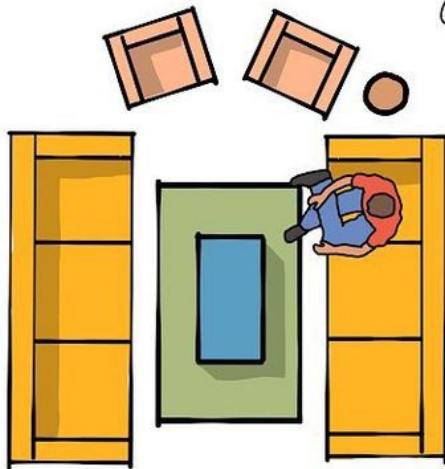

COMMON LIGHTING - CEILING DETAILS

@07SKETCHES

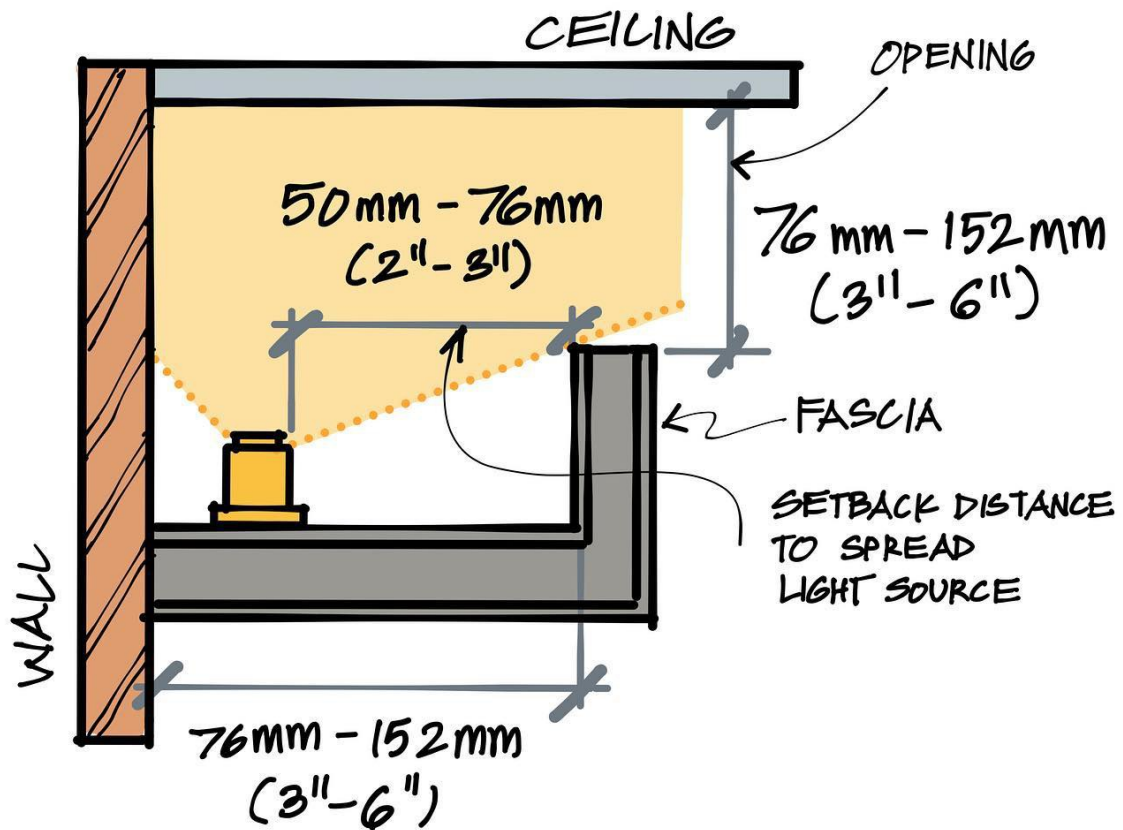

Ⓐ TYPICAL COVE APPLICATION

COMMON LIGHTING - CEILING DETAILS

@07SKETCHES

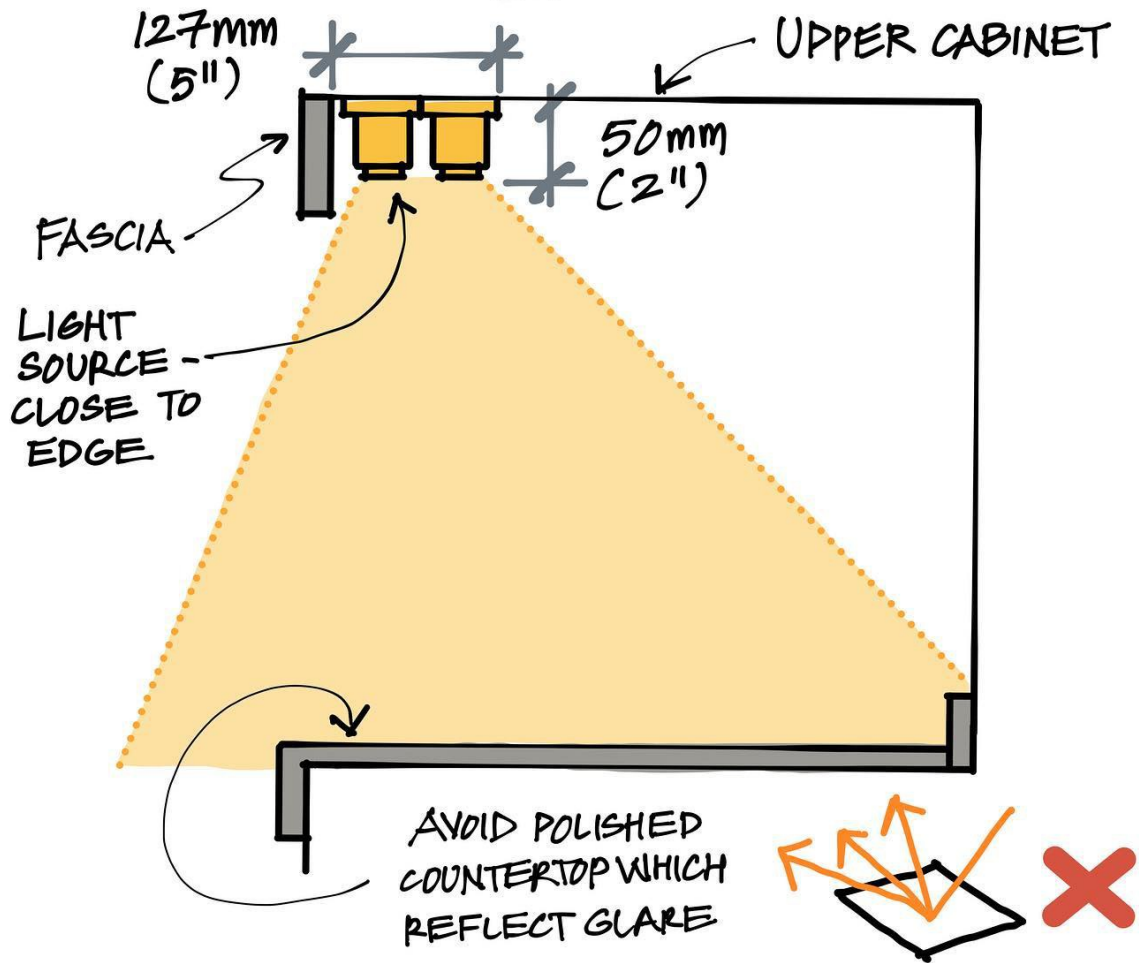

Ⓑ UNDER CABINET TASK LIGHT

COMMON LIGHTING - CEILING DETAILS

@07SKETCHES

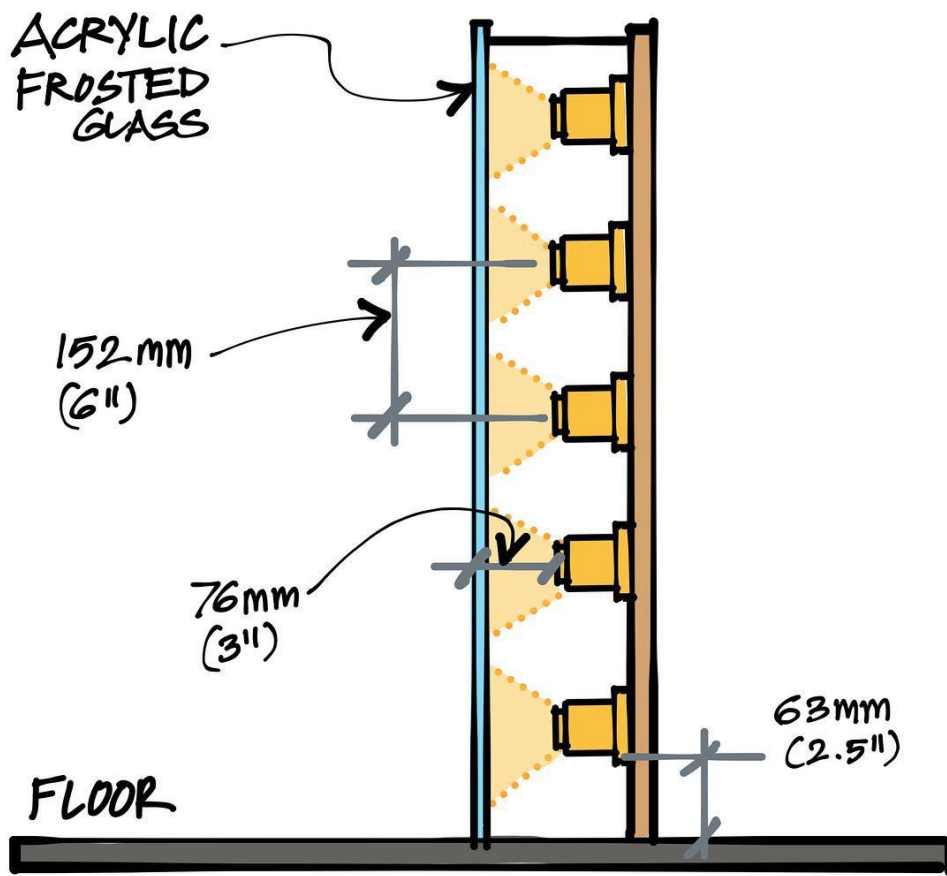

© ACRYLIC BACKLIGHTING

CLOSET DESIGNS

@07SKETCHES

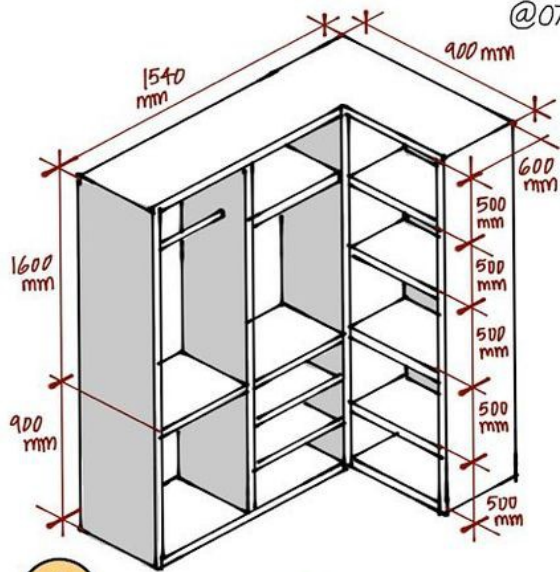

A

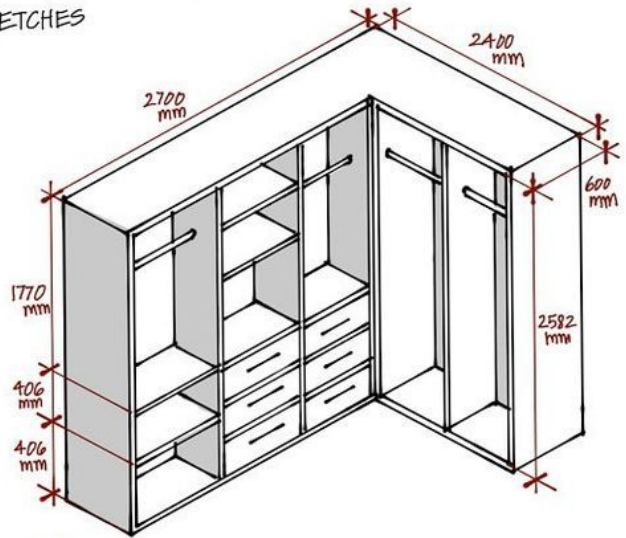

B

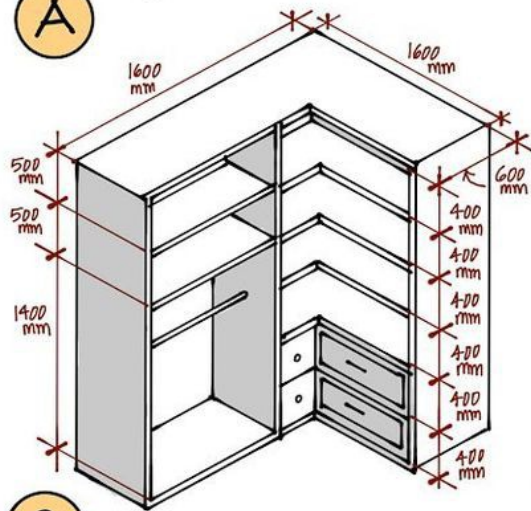

C

Discoveries.com
Engineering

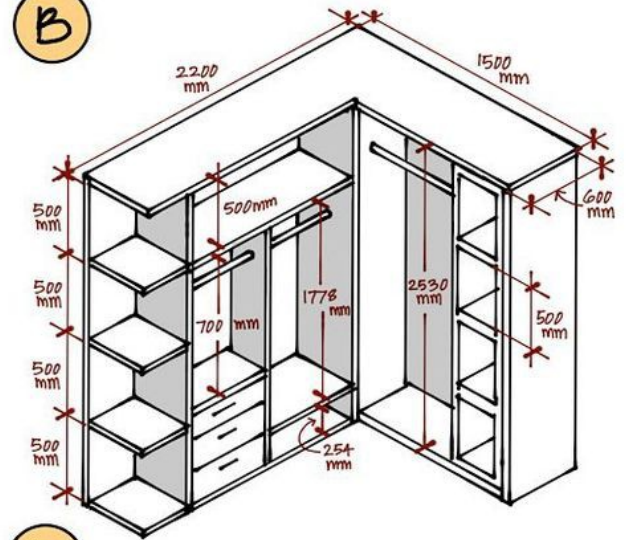

D

SINGLE ROW LAUNDRY

@07SKETCHES

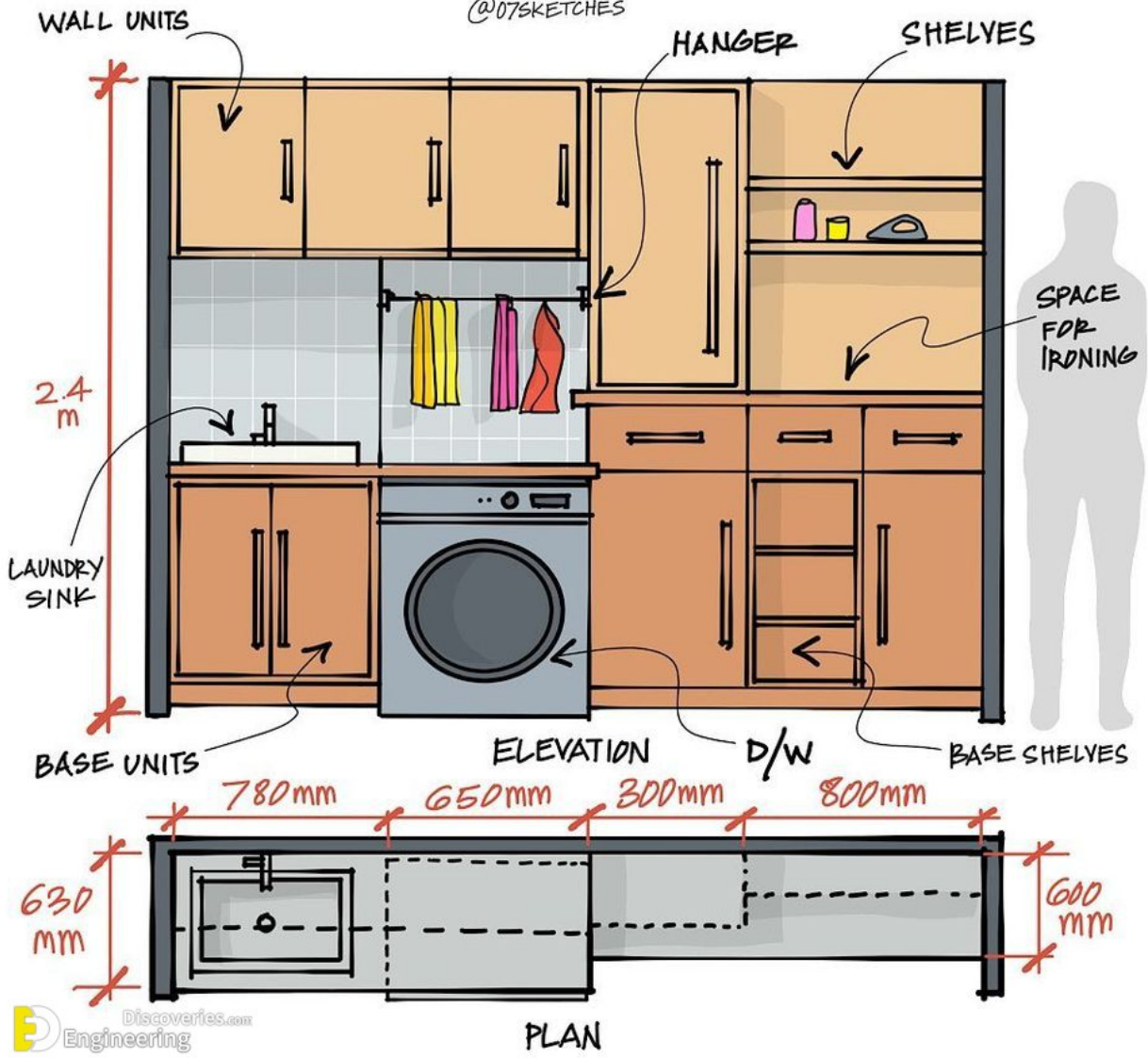

ERGONOMIC KITCHEN CABINET

@07SKETCHES

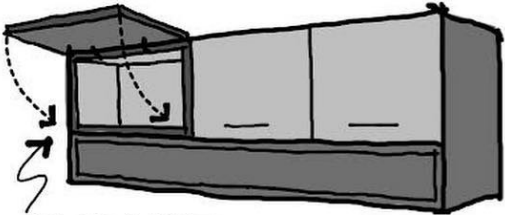

FLIP LIFT

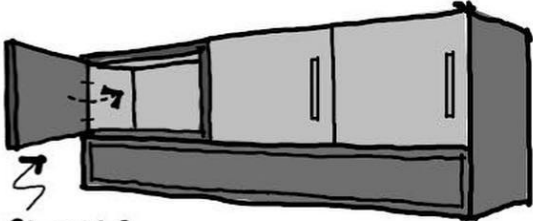

SWING

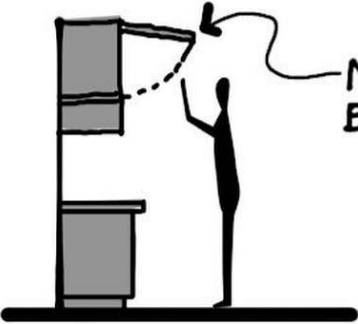
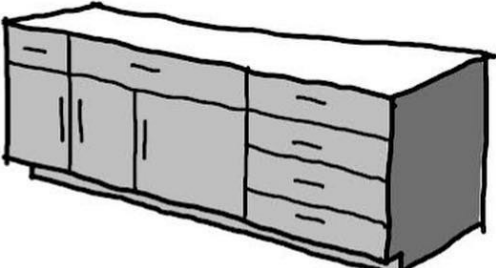
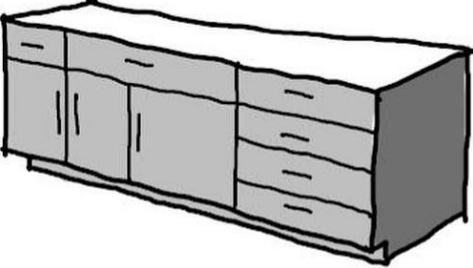

NON-
ERGONOMIC

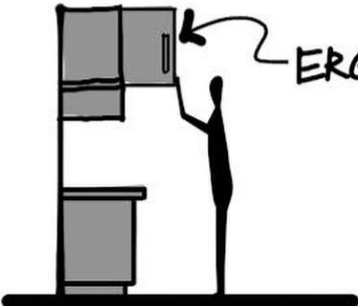

ERGONOMIC



BATHROOM CIRCULATION

@07SKETCHES

ORDER OF USAGE FREQUENCY

- 1
- 2
- 3
- 4

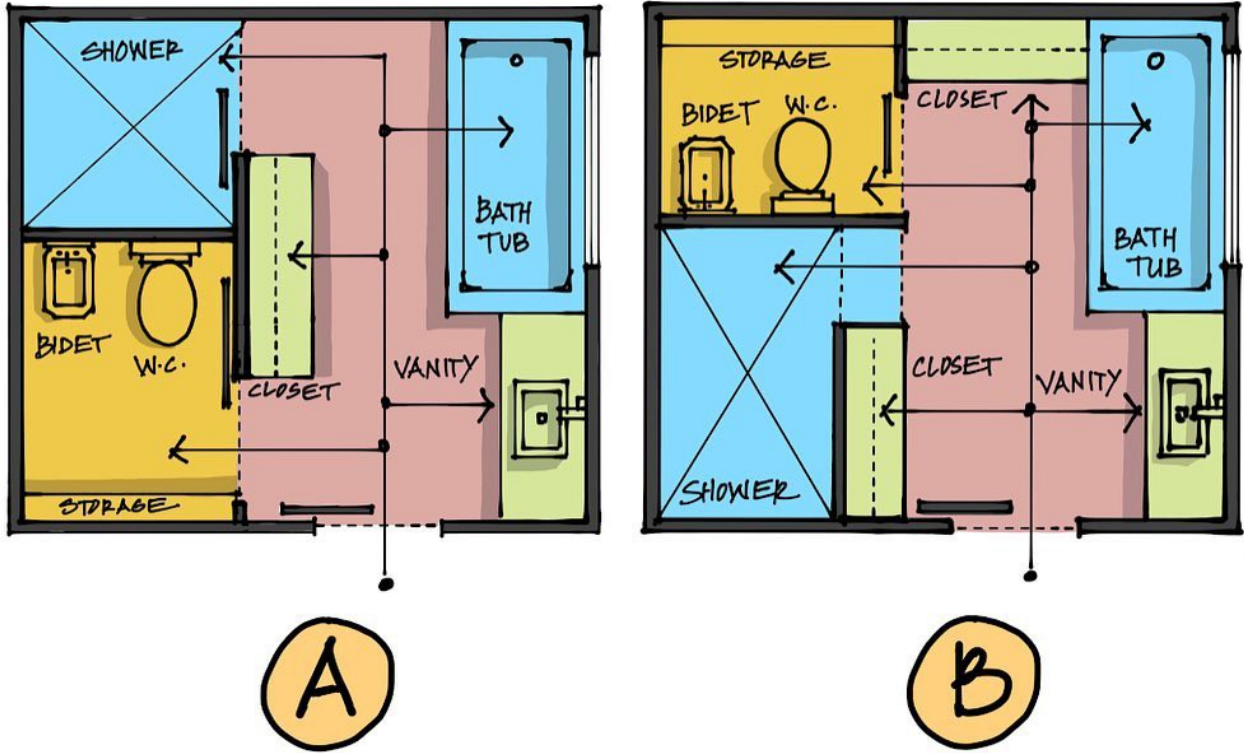

WHICH IS BETTER AND WHY ?

U-TYPE CONCRETE STAIRS

@07SKETCHES

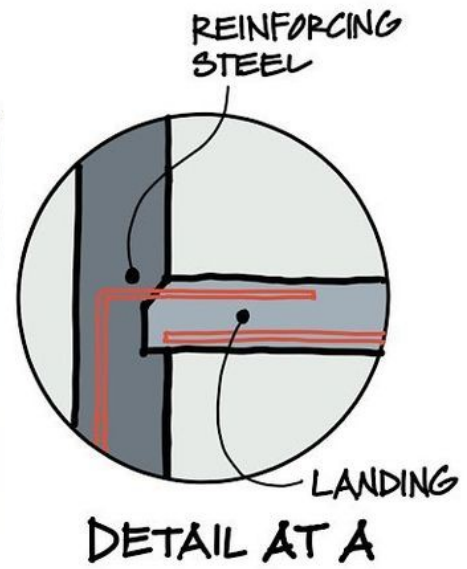
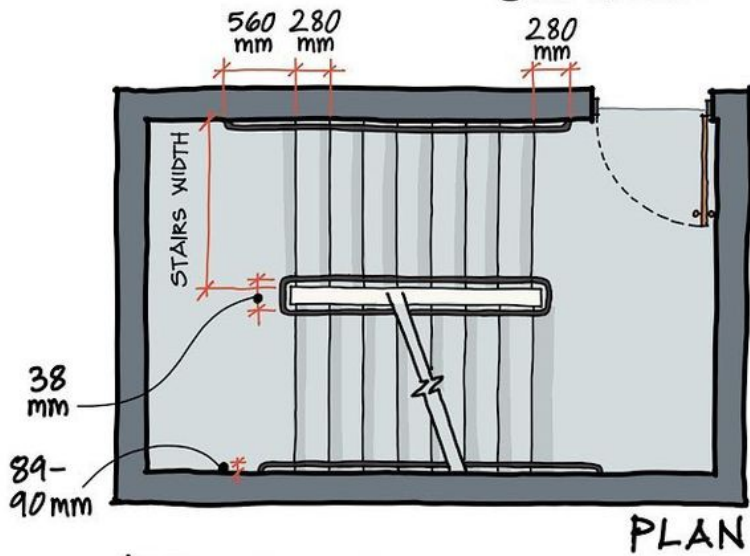

DETAIL AT A

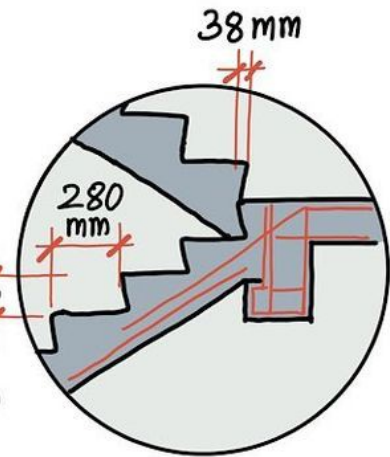
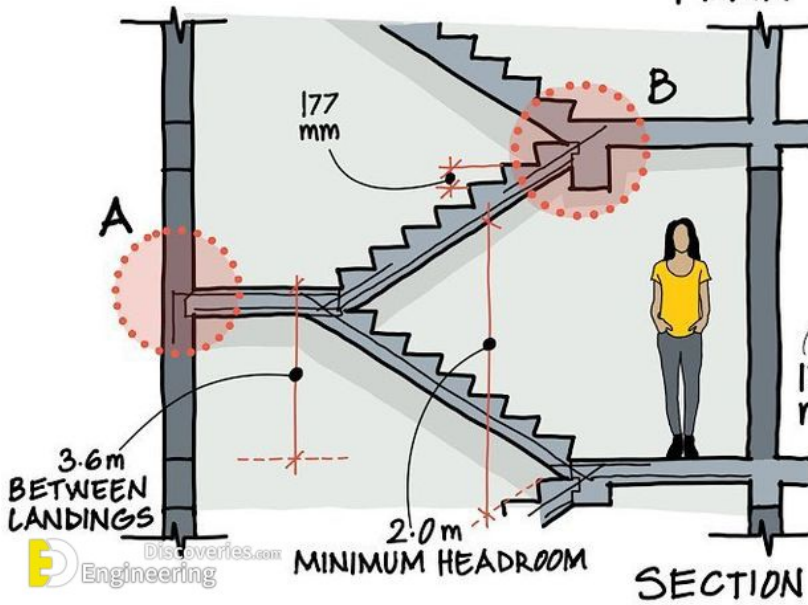

DETAIL AT B

Discoveries.com
Engineering

HOW TO PROTECT YOUR HOUSE FROM STRONG WINDS -

@07SKETCHES



① HILLS



② TREES



③ BERMS



④ SLANTING ROOF

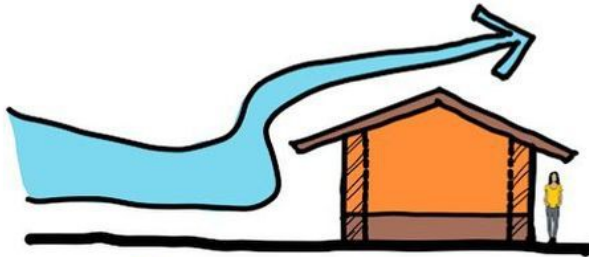

⑤ THICK WALLS



⑥ MOUNDS

Discoveries on Engineering

THE BENEFITS OF WINDBREAKERS

@07SKETCHES

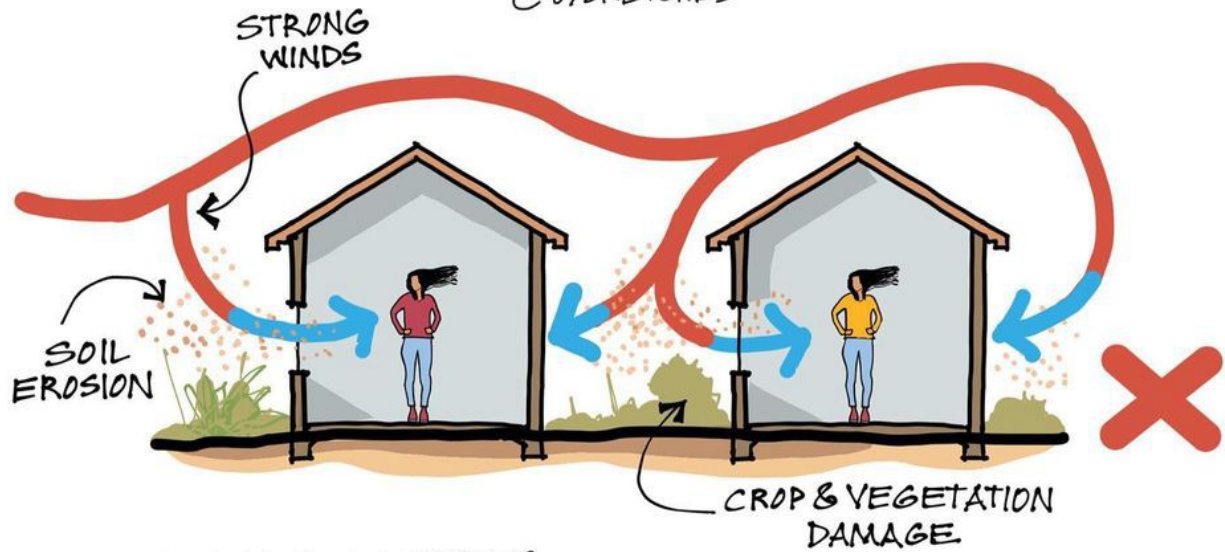

Discoveries
Engineering

WIND EFFECTS @OTSKETCHES

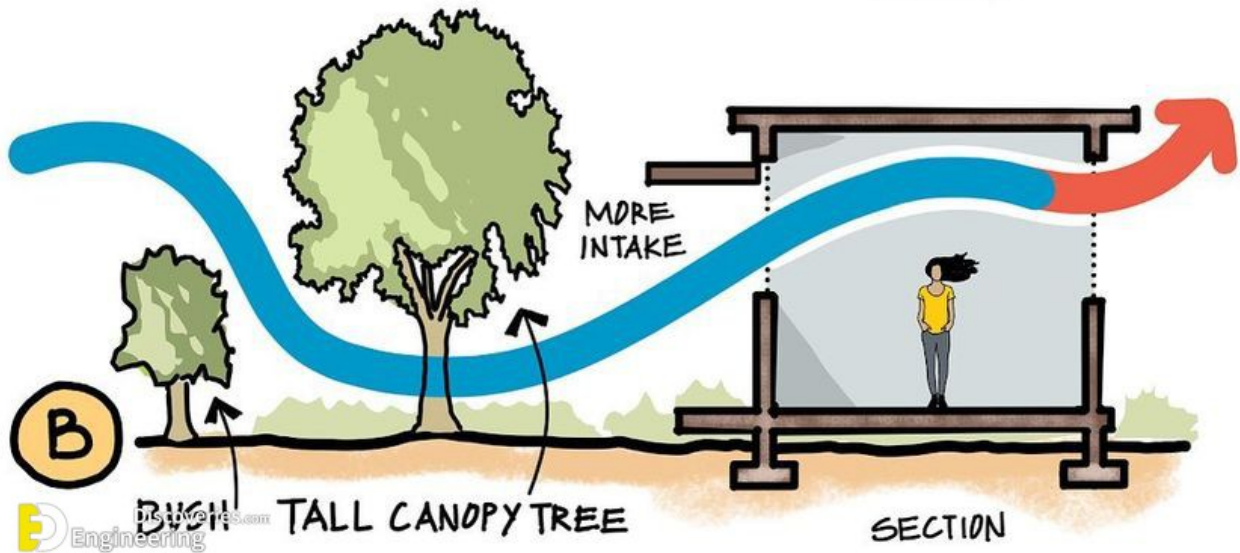
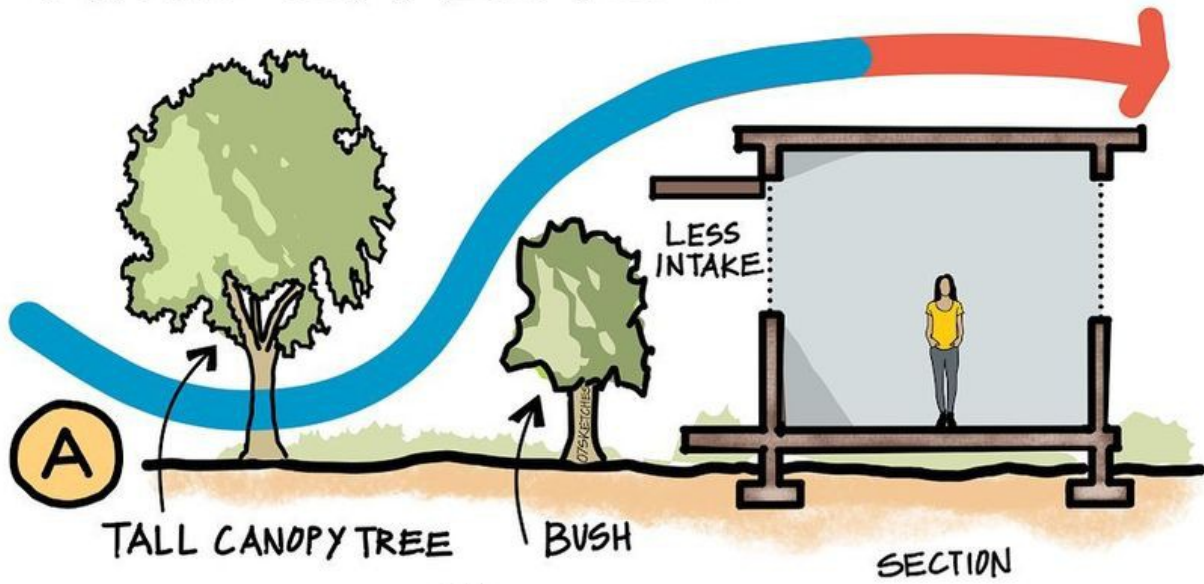

STACK VENTILATION

@07SKETCHES

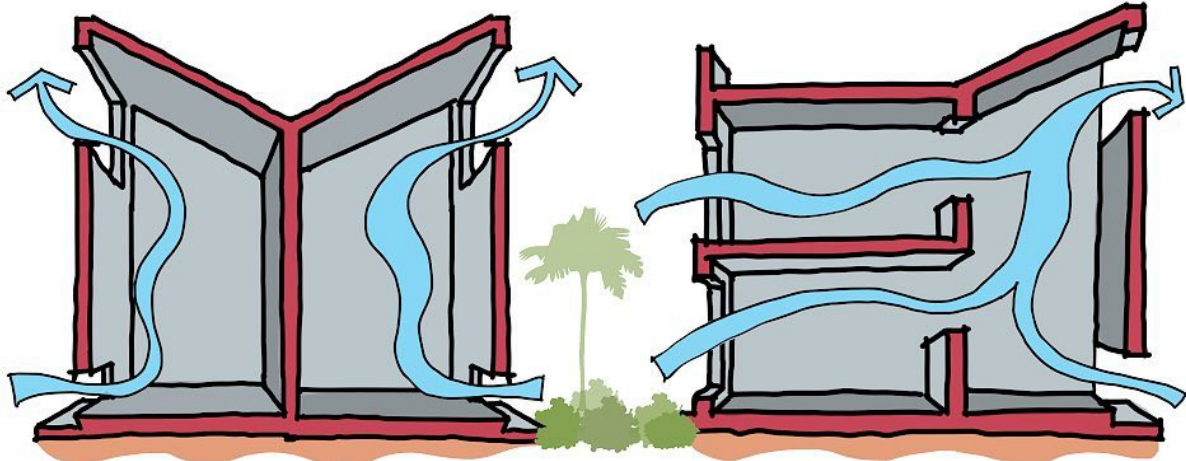

TYPE (A)

TYPE (B)

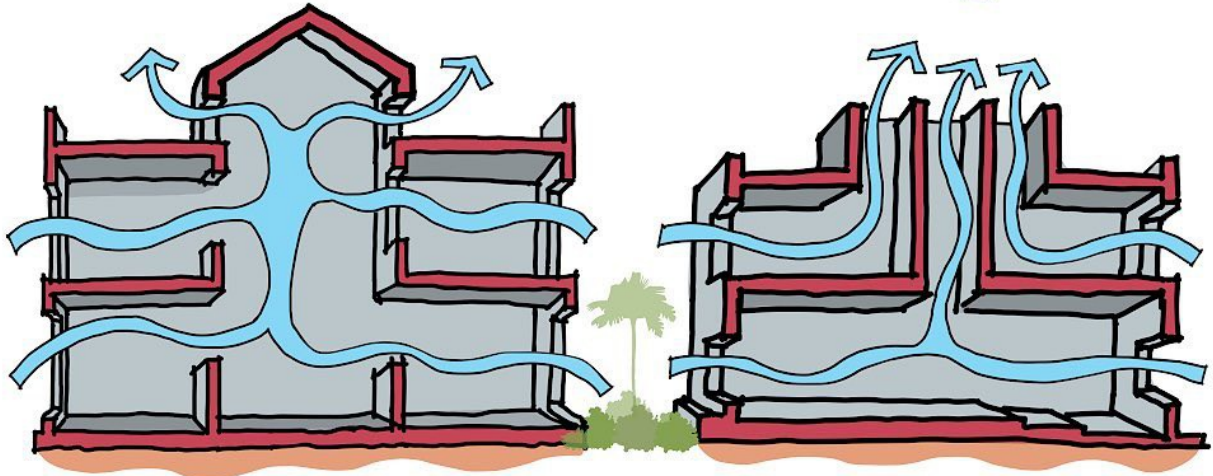

TYPE (C)

TYPE (D)

Discoveries.com
Engineering

WIND CATCHER

@07SKETCHES

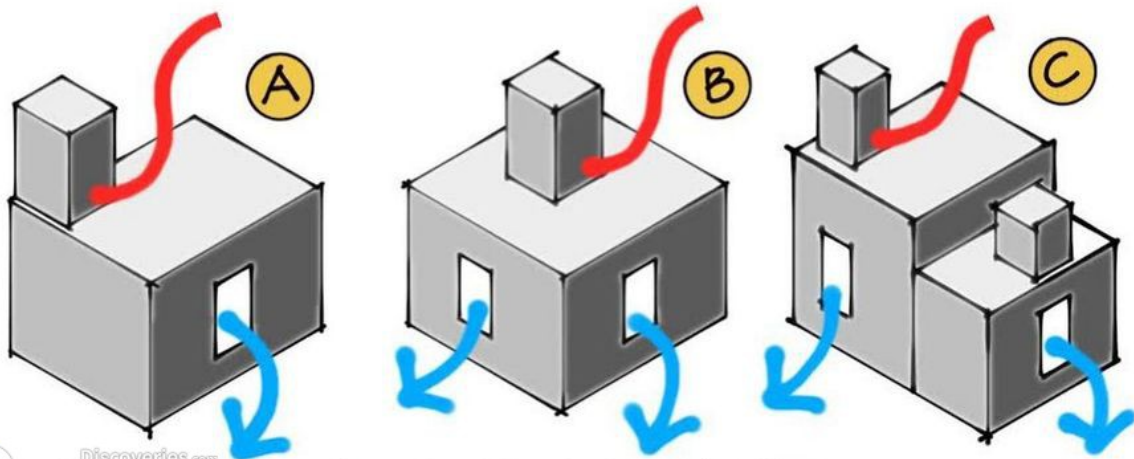
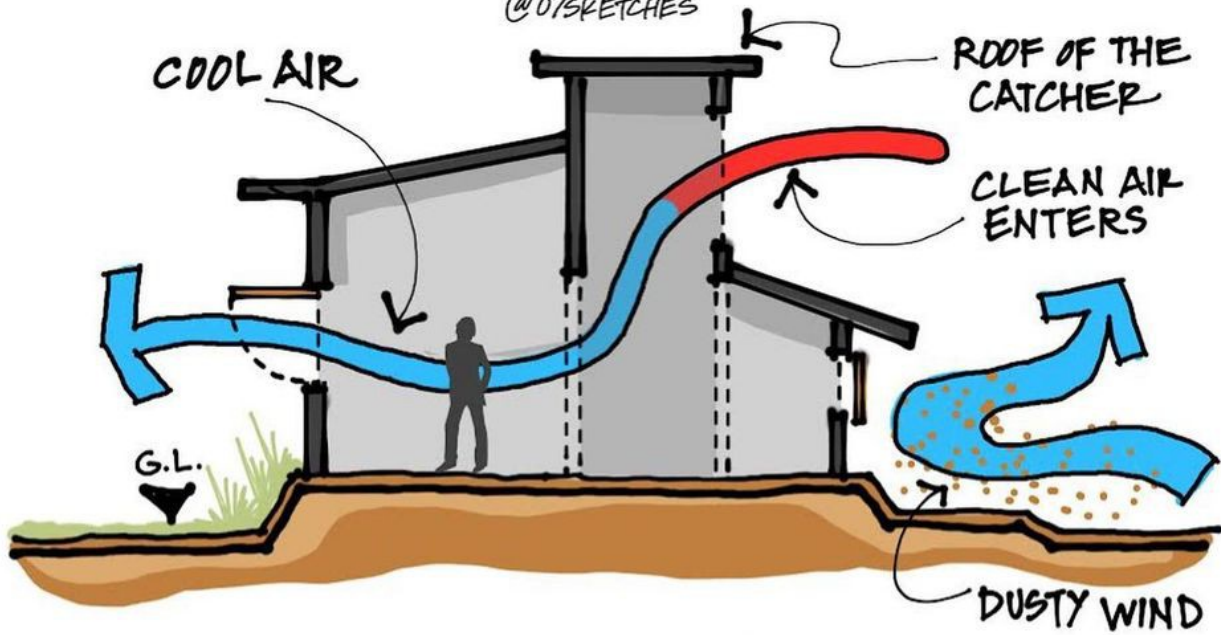

Discoveries.com
Engineering

POSITIONING WINDCATCHER

IMPORTANCE OF DRAINAGE SWALE

@07SKETCHES

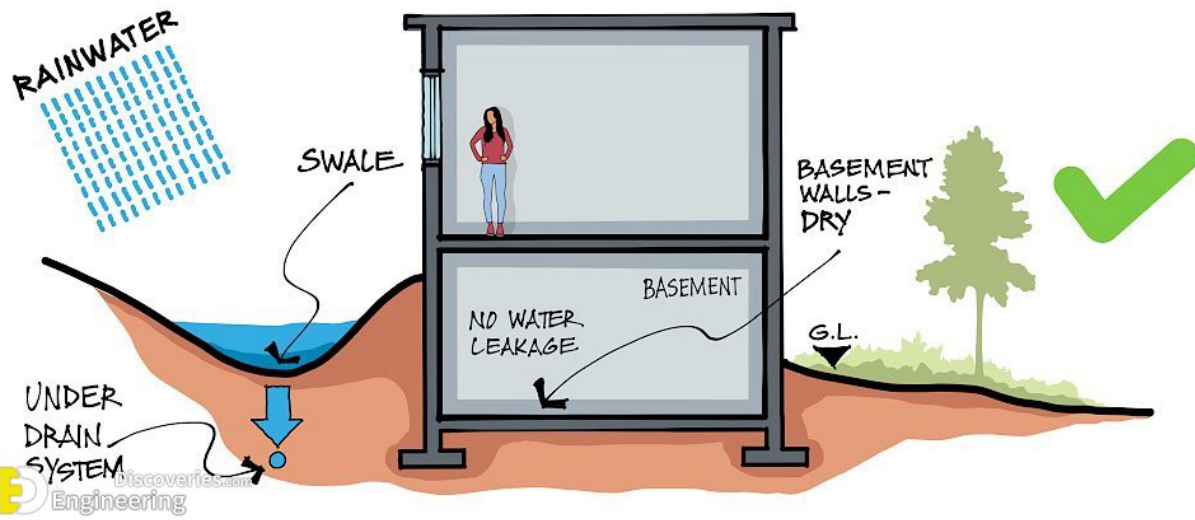
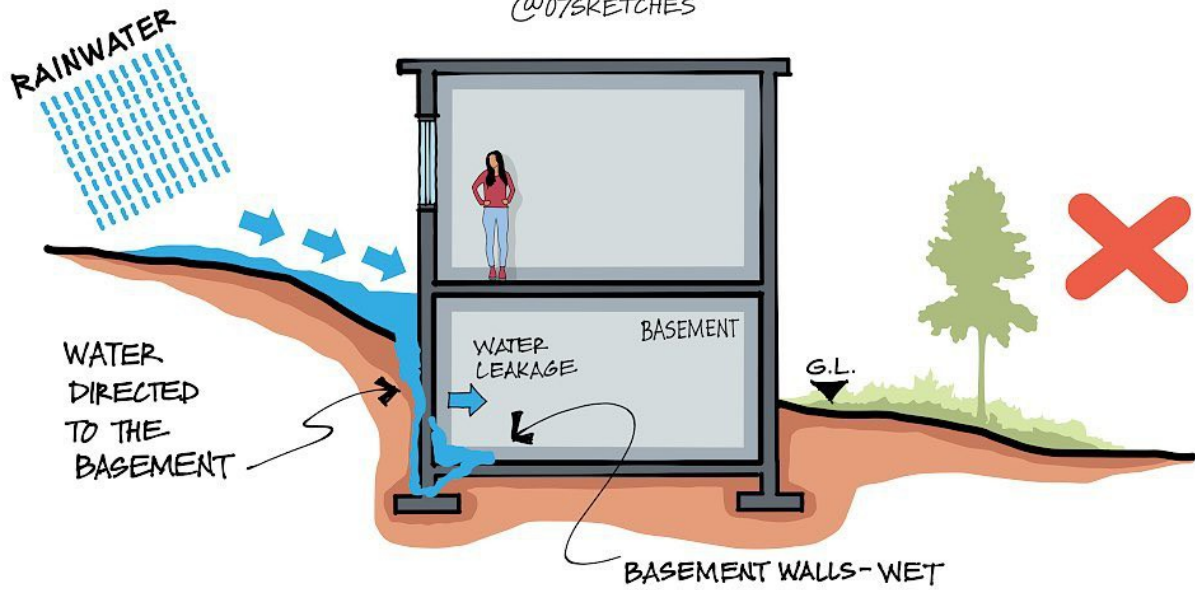

Discoveries.com
Engineering

DESIGNING ON SLOPE

@07SKETCHES

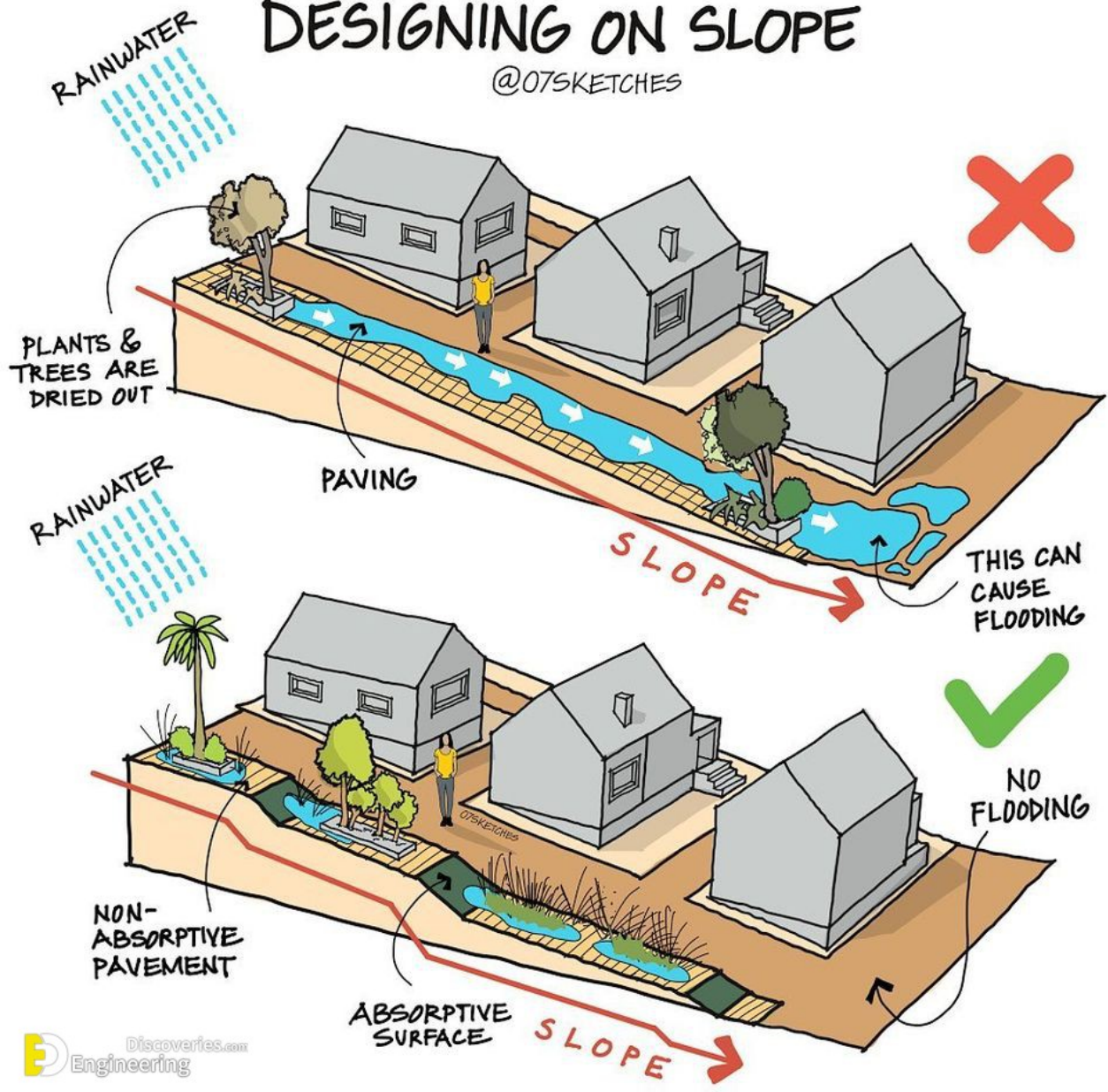

Discoveries.com
Engineering

HEAVY RAINFALL REGIONS

@07SKETCHES

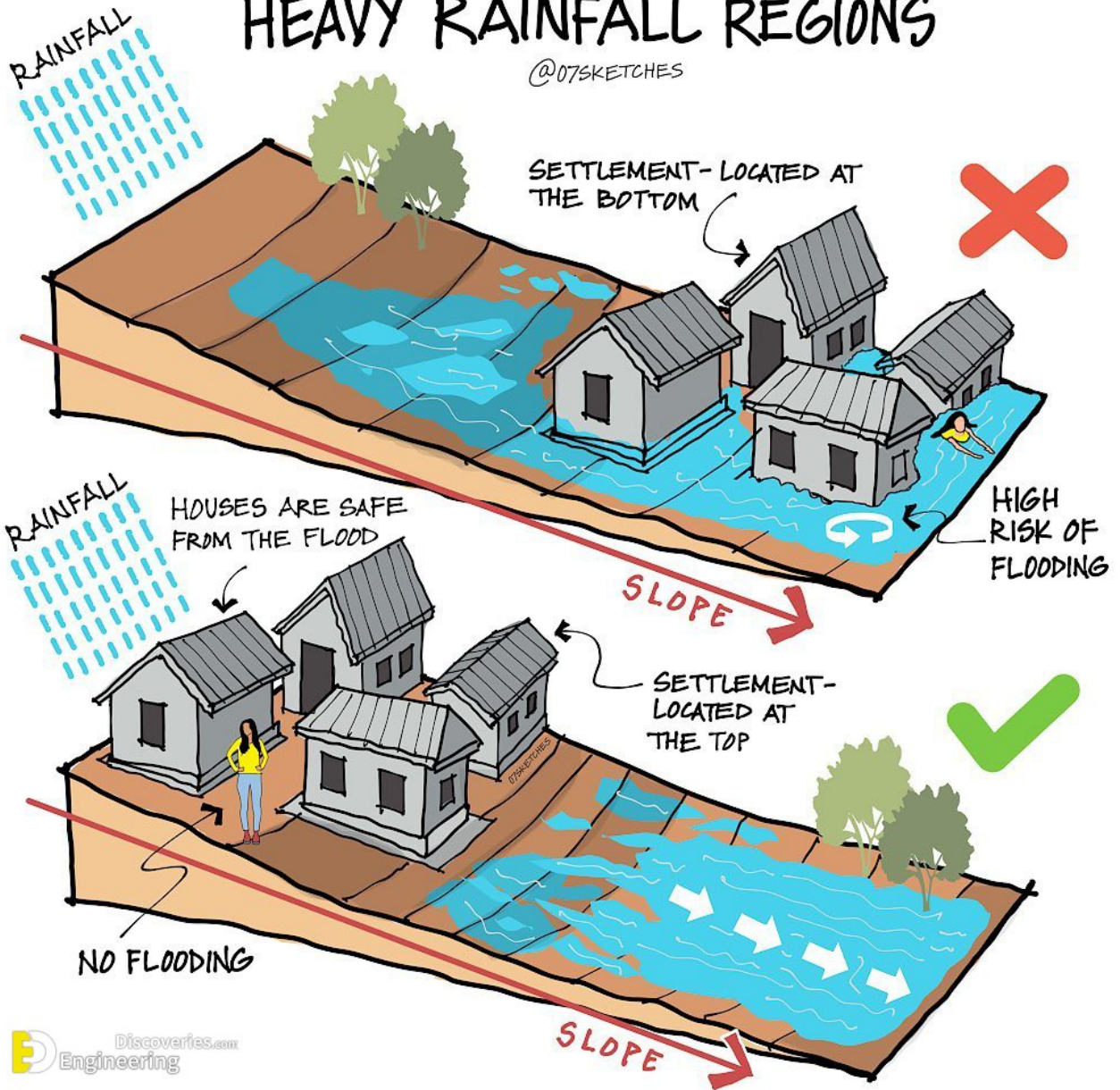

TYPES OF ENTRY DOOR STAIRS

@07SKETCHES

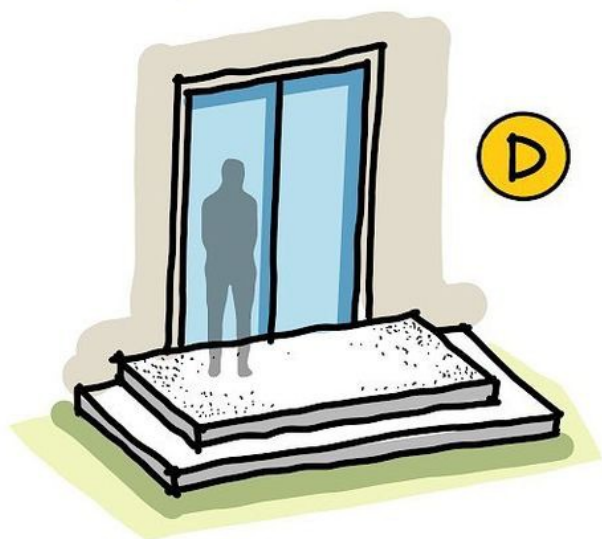
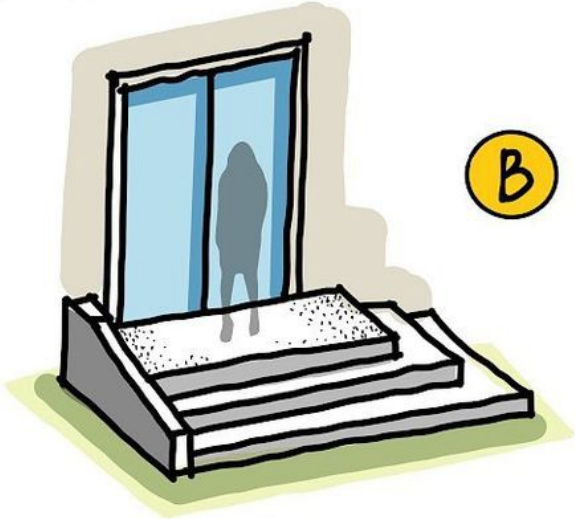

BEAT THE HEAT DURING SUMMER!

@07SKETCHES

A

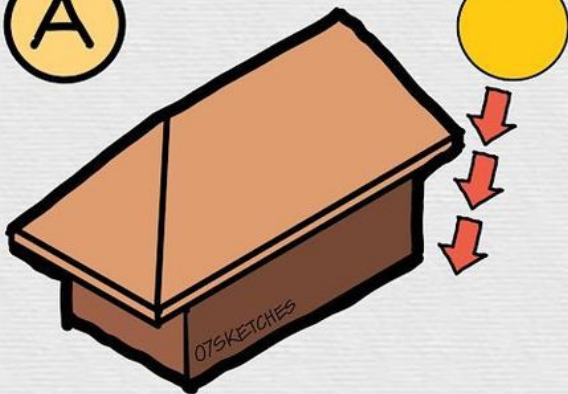

PROVIDE LARGE ROOF
TO PROMOTE SHADING

B

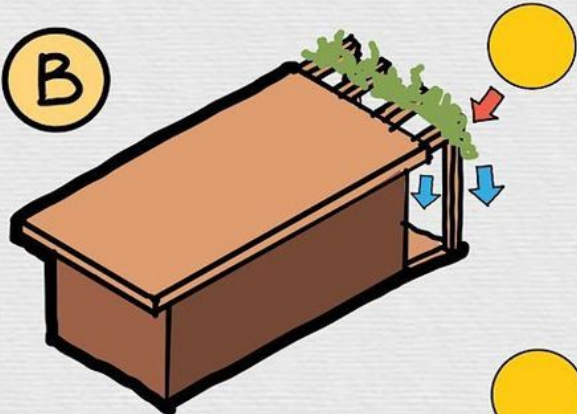

PROVIDE TRELLIS
TO PROMOTE
SHADING & COOLING

C

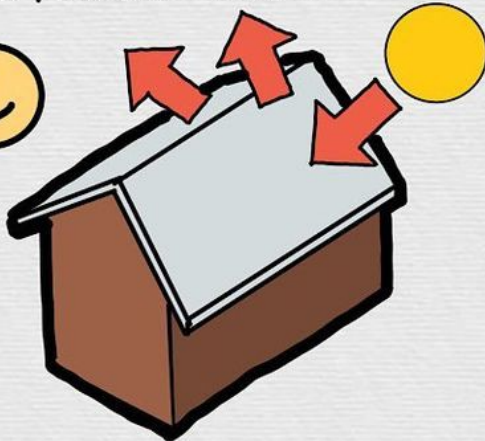

USE LIGHT COLOR MATERIALS
TO REFLECT THE SUNLIGHT

D

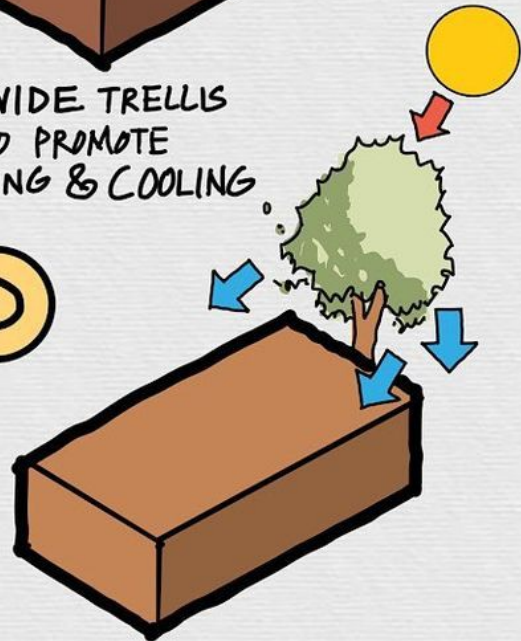

HIGH CANOPY TREES CAN
COOL THE AIR

HORIZONTAL CHIMNEY @07SKETCHES

FOR VERY COLD CLIMATES

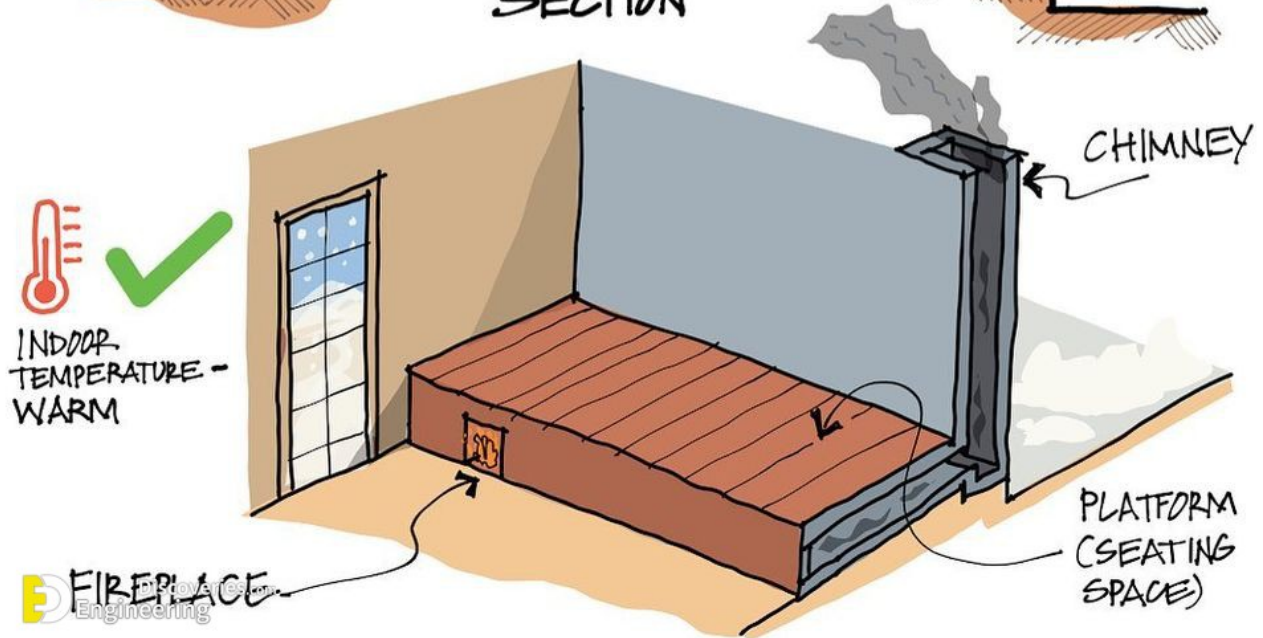
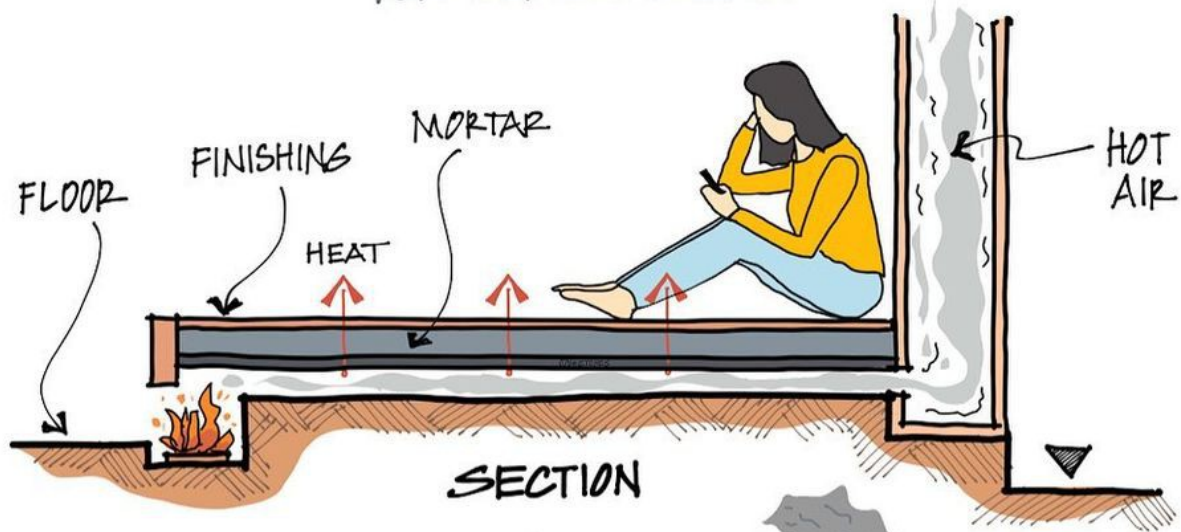

HOW TO PREVENT DIRECT SUNLIGHT ?

@07SKETCHES

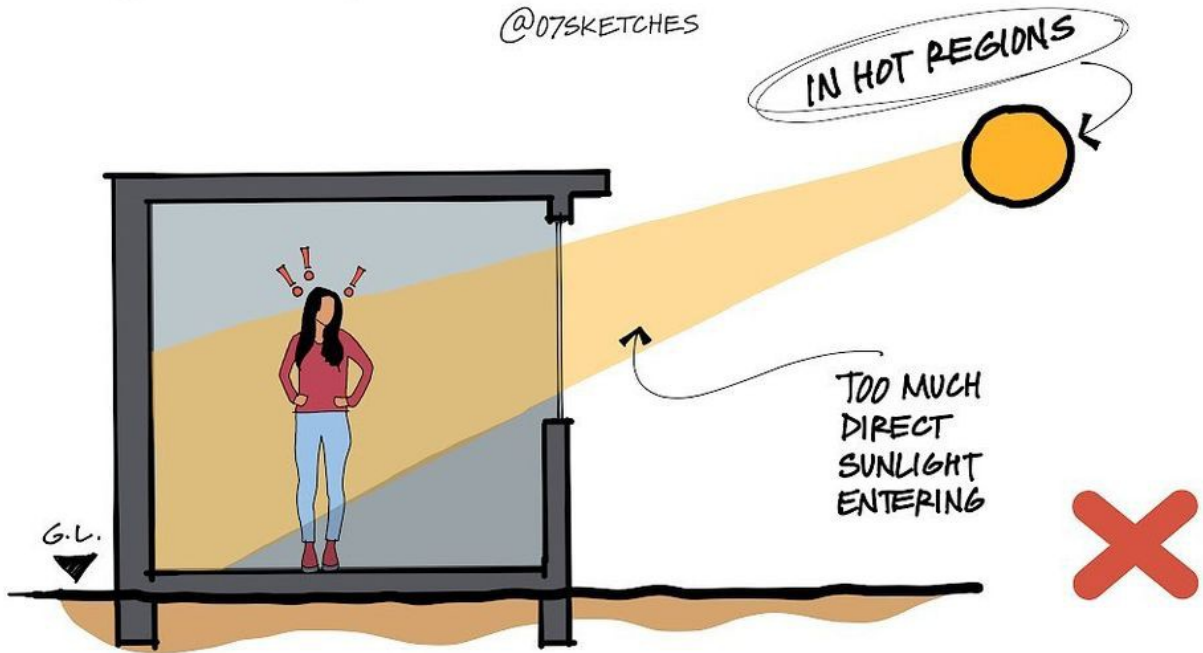

SOLUTIONS -

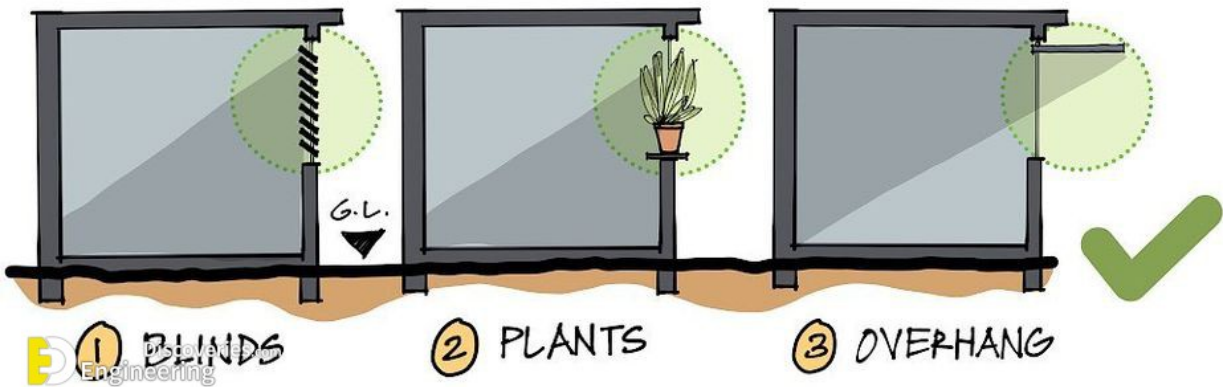

HOW TO CREATE A VERTICAL BARRIER WHILE PRESERVING VIEWS?

@07SKETCHES

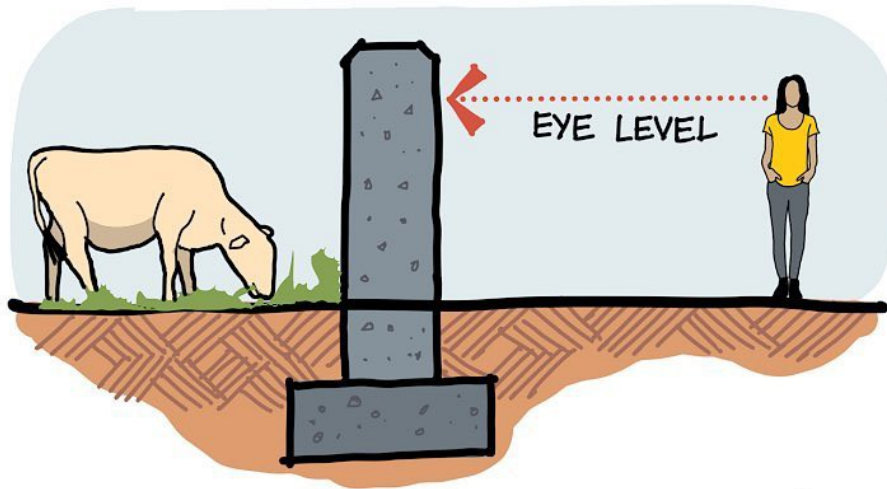

✗
TYPICAL
WALL

SOLUTION- BUILD A-'HA-HA'WALL

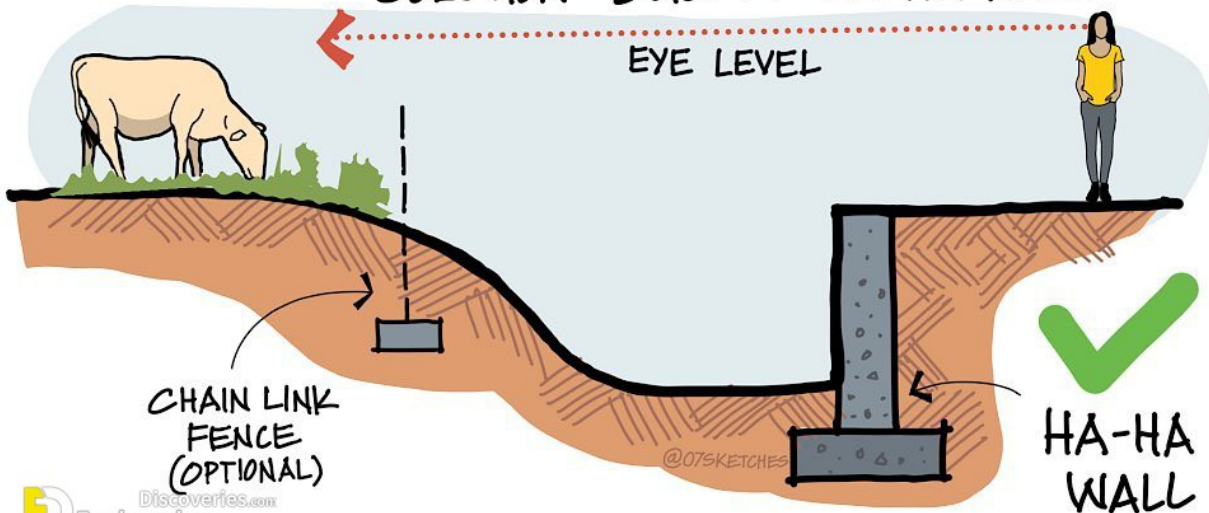

✓
HA-HA
WALL

Discoveries.com
Engineering

ROOM GETTING HEATED DUE TO DIRECT SUNLIGHT

EXTERIOR DESIGN @07SKETCHES

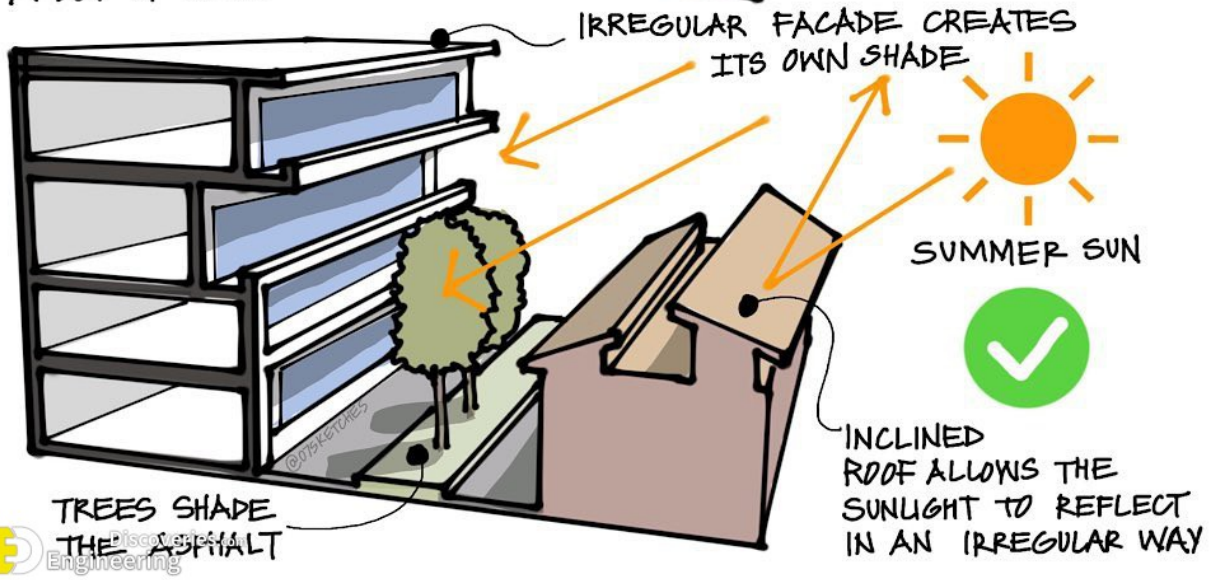
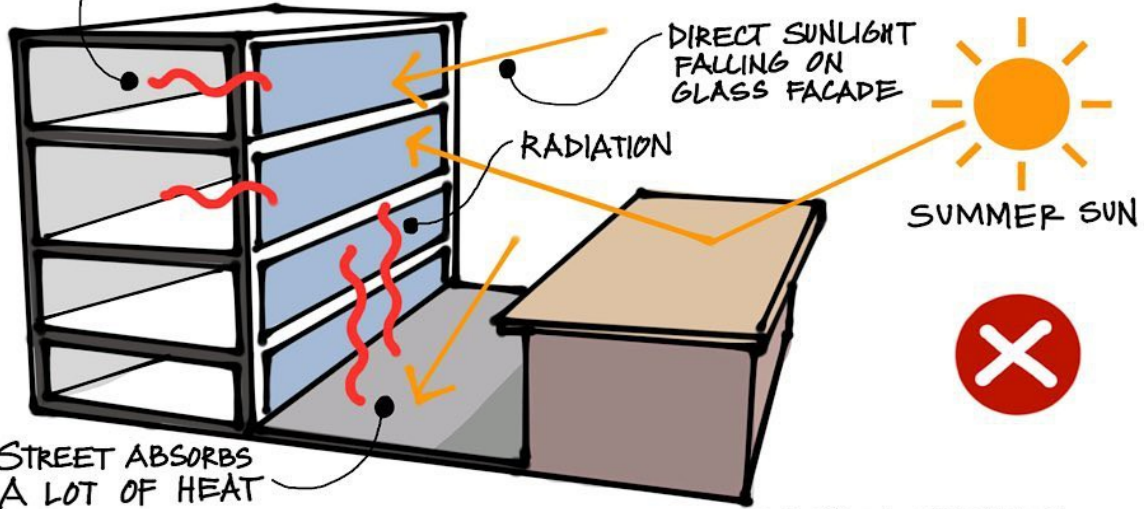

DORMER DETAILS AND TYPES @07SKETCHES

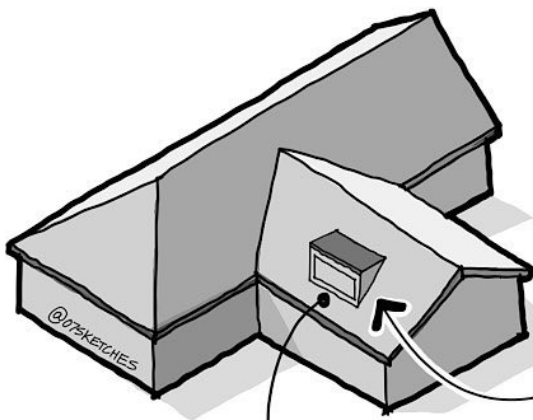

FLAT DORMER

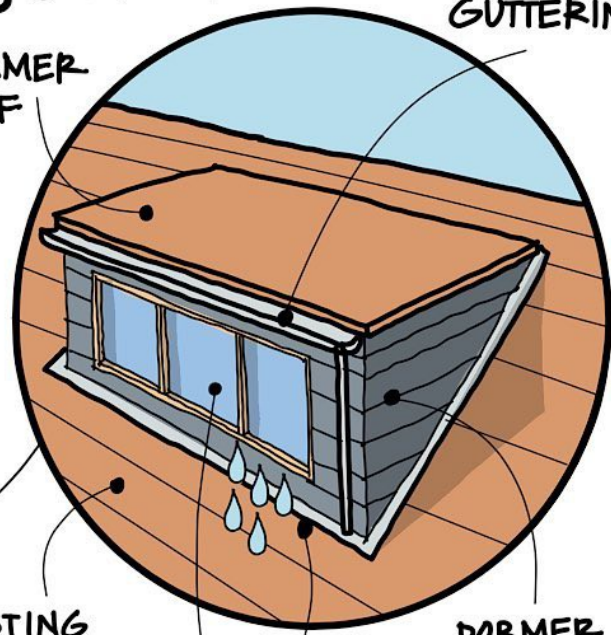

EXISTING ROOF

WINDOW FLASHING

DORMER

FLASHING

(A) GABLE

(B) ARCHED

(C) HIP

(D) SHED

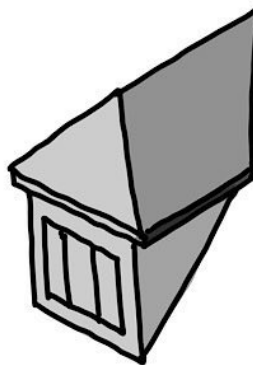
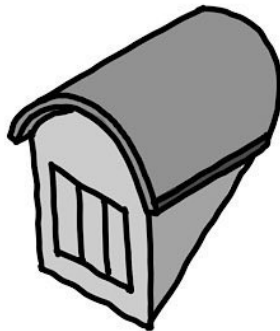
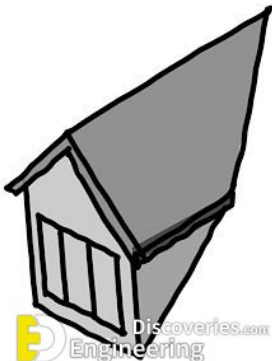

TYPES OF STAIRS @OTSKETCHES

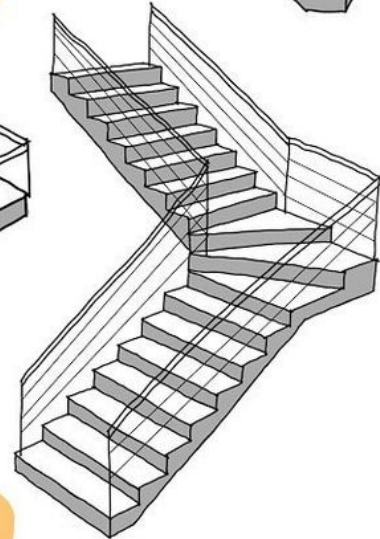
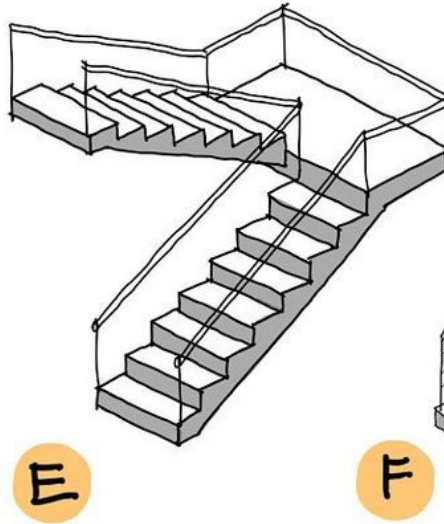
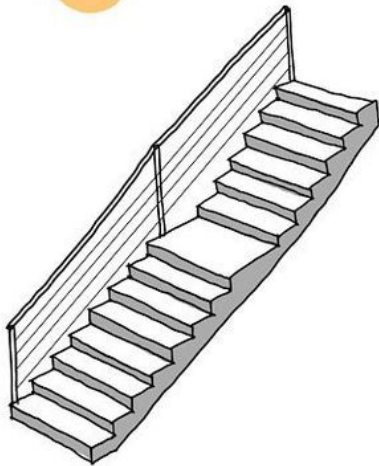
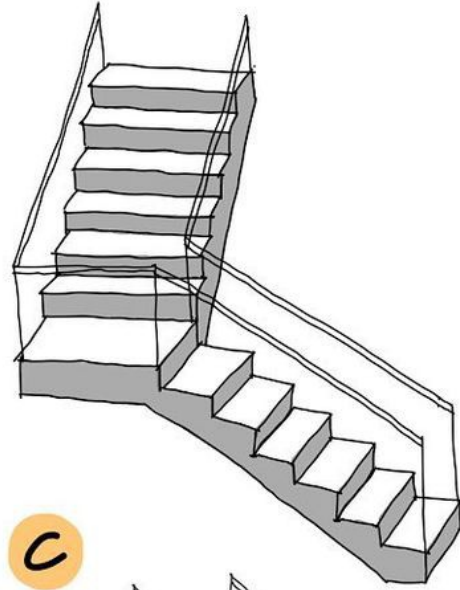
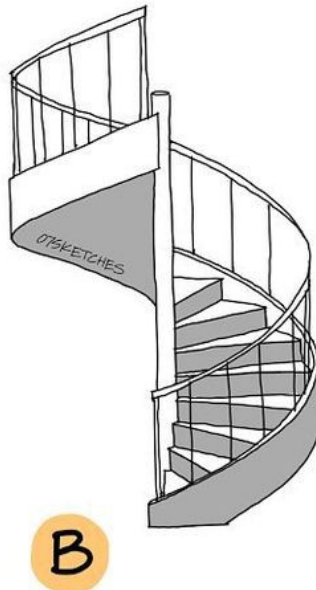
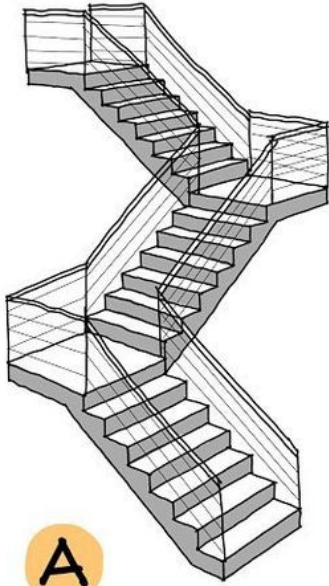

D Discoveries.com
Engineering

LIGHT UP YOUR INDOOR STAIRCASE

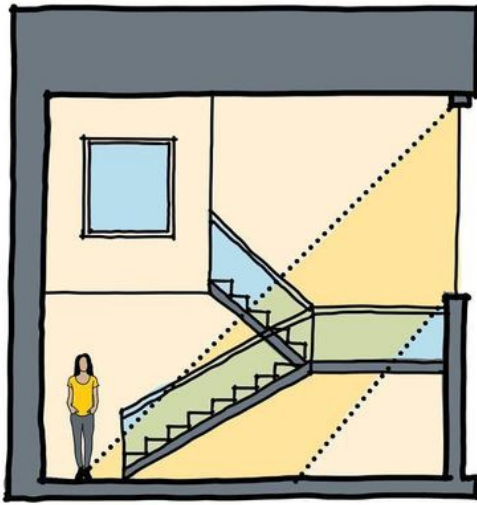

① WINDOW

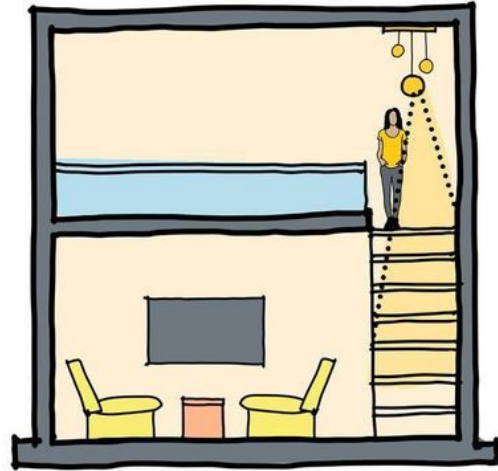

② CEILING/PENDANT L.

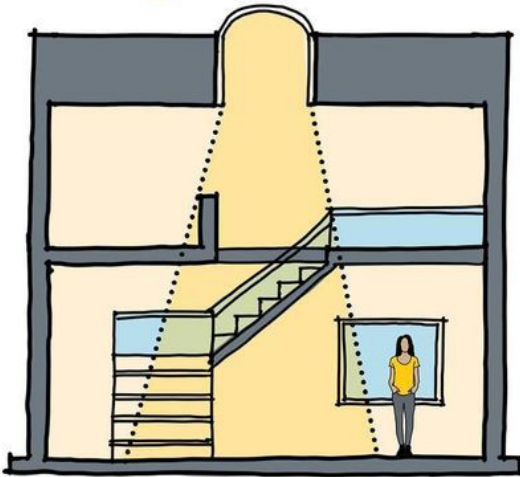

③ ATRIUM

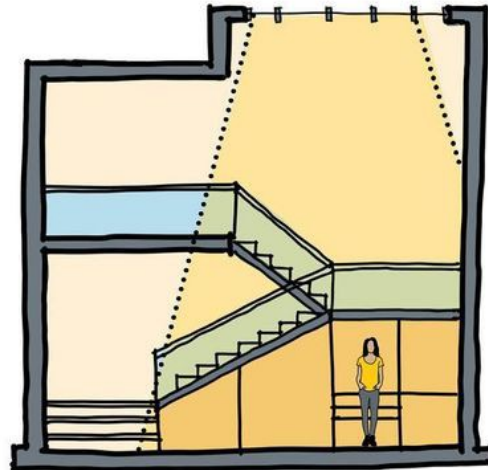

④ GLASS ROOF

concepts @07SKETCHES
CREATOR

KITCHEN DESIGN @07SKETCHES

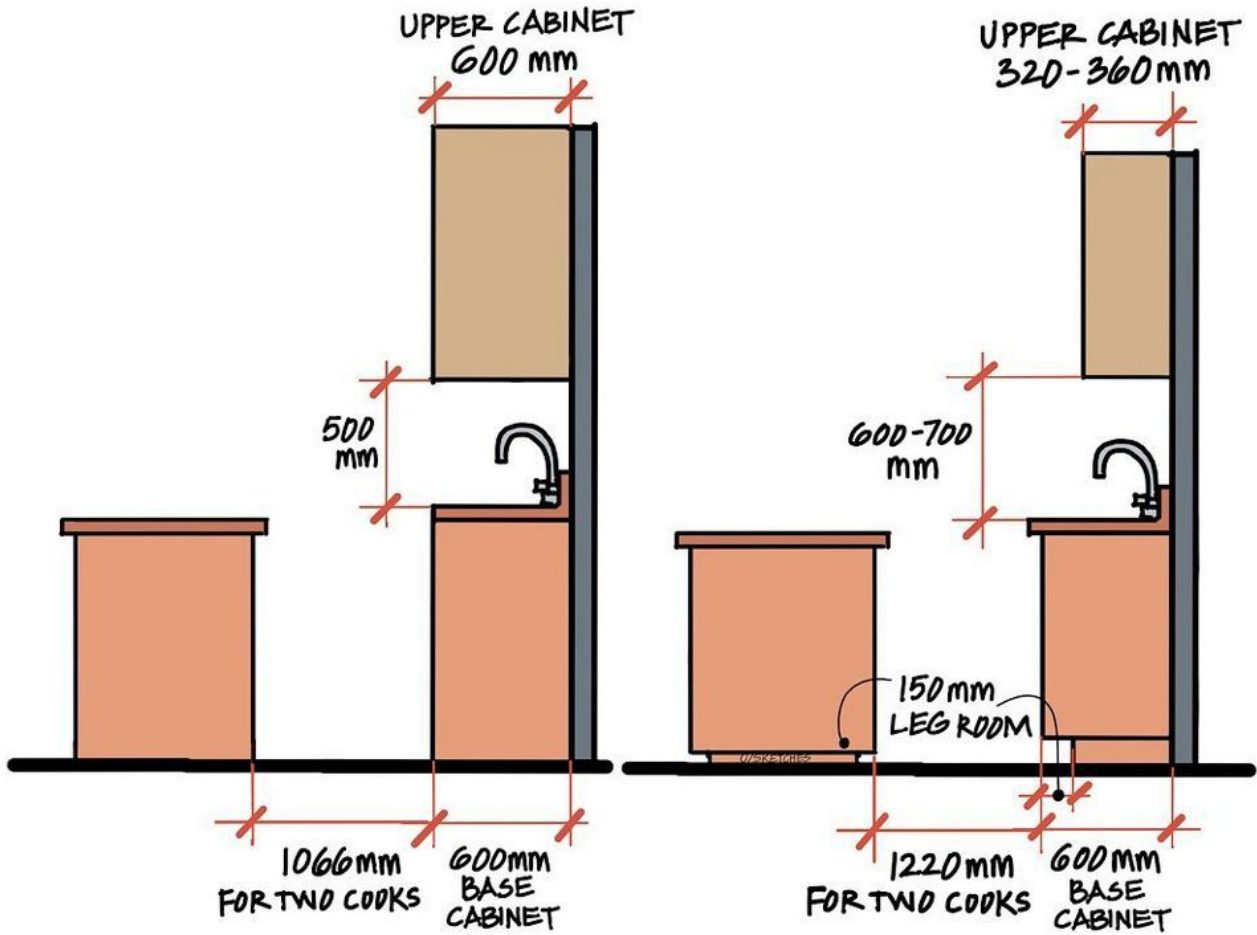

KITCHEN DESIGN

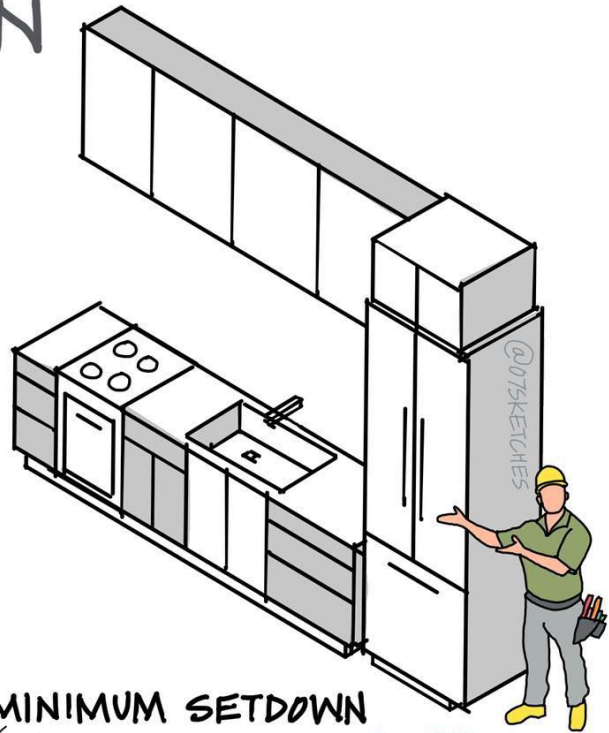
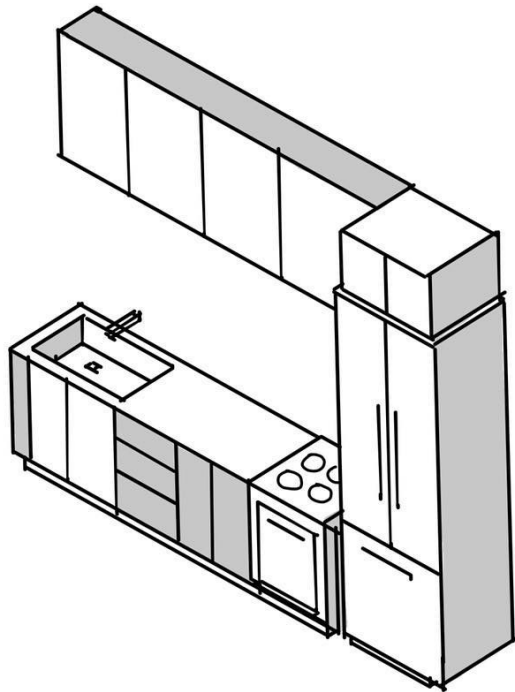

MINIMUM SETDOWN

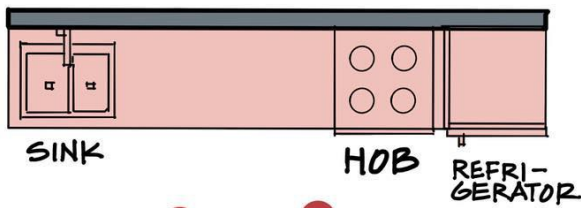
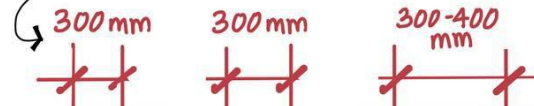

SINK

HOB

REFRI-
GERATOR

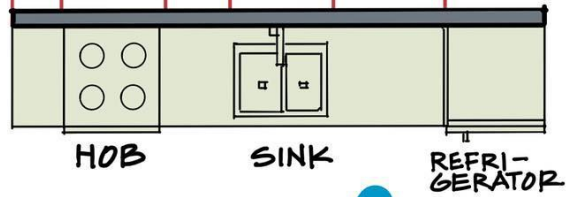

HOB

SINK

REFRI-
GERATOR

@OTSKETCHES

LIVING ROOM- INTERIOR DESIGN

@07SKETCHES

- ✓ EXPOSED BRICK WALL
- ✓ DARK COLOUR SCHEME

COLOUR SCHEME

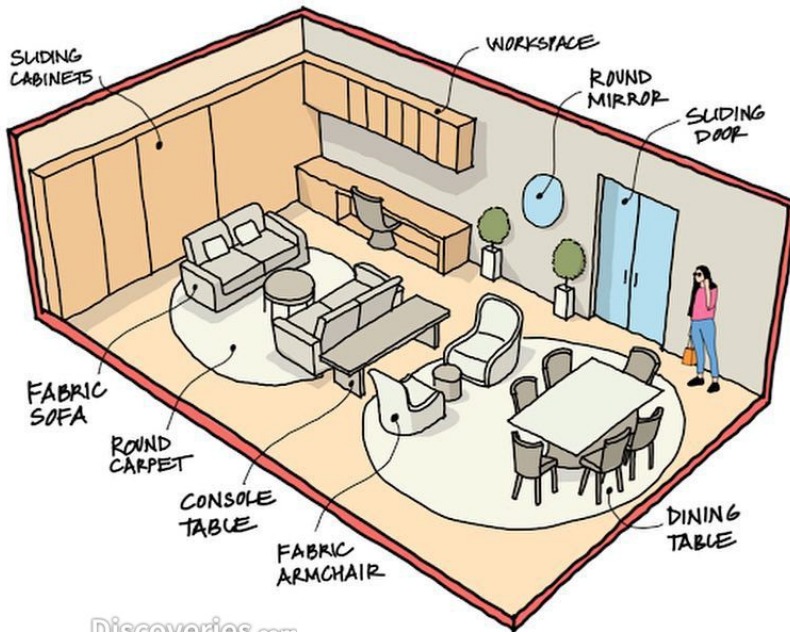
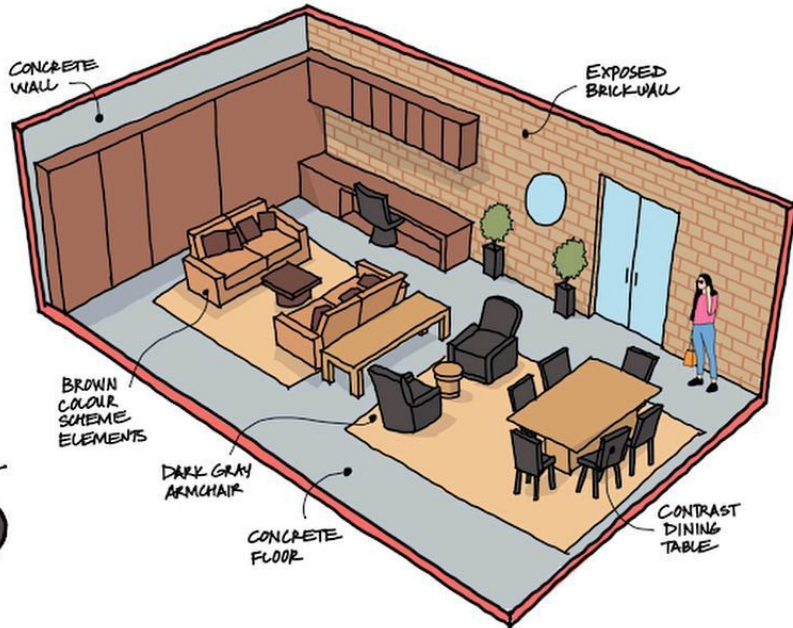
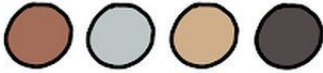

- ✓ SLEEK
- ✓ LIGHT COLOUR SCHEME

COLOUR SCHEME

